



CertiFiber® Pro

Optical Loss Test Set

Users Manual

May 2013 (English)

©2013 Fluke Corporation

All product names are trademarks of their respective companies.

LIMITED WARRANTY AND LIMITATION OF LIABILITY

Each Fluke Networks product is warranted to be free from defects in material and workmanship under normal use and service. The warranty period for the mainframe is one year and begins on the date of purchase. Parts, accessories, product repairs and services are warranted for 90 days, unless otherwise stated. Ni-Cad, Ni-MH and Li-Ion batteries, cables or other peripherals are all considered parts or accessories. The warranty extends only to the original buyer or end user customer of a Fluke Networks authorized reseller, and does not apply to any product which, in Fluke Networks' opinion, has been misused, abused, altered, neglected, contaminated, or damaged by accident or abnormal conditions of operation or handling. Fluke Networks warrants that software will operate substantially in accordance with its functional specifications for 90 days and that it has been properly recorded on non-defective media. Fluke Networks does not warrant that software will be error free or operate without interruption.

Fluke Networks authorized resellers shall extend this warranty on new and unused products to end-user customers only but have no authority to extend a greater or different warranty on behalf of Fluke Networks. Warranty support is available only if product is purchased through a Fluke Networks authorized sales outlet or Buyer has paid the applicable international price. Fluke Networks reserves the right to invoice Buyer for importation costs of repair/replacement parts when product purchased in one country is submitted for repair in another country.

Fluke Networks warranty obligation is limited, at Fluke Networks option, to refund of the purchase price, free of charge repair, or replacement of a defective product which is returned to a Fluke Networks authorized service center within the warranty period.

To obtain warranty service, contact your nearest Fluke Networks authorized service center to obtain return authorization information, then send the product to that service center, with a description of the difficulty, postage and insurance prepaid (FOB destination). Fluke Networks assumes no risk for damage in transit. Following warranty repair, the product will be returned to Buyer, transportation prepaid (FOB destination). If Fluke Networks determines that failure was caused by neglect, misuse, contamination, alteration, accident or abnormal condition of operation or handling, or normal wear and tear of mechanical components, Fluke Networks will provide an estimate of repair costs and obtain authorization before commencing the work. Following repair, the product will be returned to the Buyer transportation prepaid and the Buyer will be billed for the repair and return transportation charges (FOB Shipping point).

THIS WARRANTY IS BUYER'S SOLE AND EXCLUSIVE REMEDY AND IS IN LIEU OF ALL OTHER WARRANTIES, EXPRESS OR IMPLIED, INCLUDING BUT NOT LIMITED TO ANY IMPLIED WARRANTY OR MERCHANTABILITY OR FITNESS FOR A PARTICULAR PURPOSE. FLUKE NETWORKS SHALL NOT BE LIABLE FOR ANY SPECIAL, INDIRECT, INCIDENTAL OR CONSEQUENTIAL DAMAGES OR LOSSES, INCLUDING LOSS OF DATA, ARISING FROM ANY CAUSE OR THEORY.

Since some countries or states do not allow limitation of the term of an implied warranty, or exclusion or limitation of incidental or consequential damages, the limitations and exclusions of this warranty may not apply to every buyer. If any provision of this Warranty is held invalid or unenforceable by a court or other decision-maker of competent jurisdiction, such holding will not affect the validity or enforceability of any other provision.

4/04

Fluke Networks
PO Box 777
Everett, WA 98206-0777
USA

Contents

Chapter 1 Get Acquainted

Overview of the CertiFiber Pro Optical Loss Test Set Modules	1
Contact Fluke Networks	2
Register Your Product	2
Technical Reference Handbook	3
Additional Resources	3
Supplements and Updated Manuals	3
Kit Contents	3
CFP-100-M Kit	4
CFP-100-S Kit	4
CFP-100-Q Kit	5
CFP-Q-ADD Kit	6
 Safety Information	7
Connectors, Keys, and LEDs	10
The Home Screen for CertiFiber Pro Modules	15
AC Adapter and Battery	18
Charge the Battery	18
Check the Battery Status	18
How to Use the Touchscreen	21
Verify Operation	23
Change the Language	23
Buttons to Do Tests and Save Results	23
Overview of Memory Functions	25
Options for Cable IDs	26

How to Remove and Install the Connector Adapters ..	27
How to Install a Strap	29
How to Remove or Install a Module	29
About LinkWare and LinkWare Stats Software	31

Chapter 2 How to Clean Fiber Endfaces

How to Use a Fluke Networks IBC OneClick Cleaner ...	36
How to Use Wipes, Swabs, and Solvent	38
To Clean Bulkhead Connectors	38
To Clean the Optical Connectors on the Modules .	39
To Clean Fiber Adapters	39
To Clean Connector Ends	39

Chapter 3 How to Certify Fiber Cabling

Requirements for Reliable Fiber Test Results	41
About the Reference for Fiber Tests	42
When to Set the Reference	42
Good Reference Values	43
How to See the Reference Values	44
About Test Reference Cords and Mandrels	44
About the EF-TRC (Encircled-Flux Test Reference Cords)	44
About APC Connectors	46
About Standard Mandrels	47
Settings for Fiber Tests	48
About 1 Jumper Reference Connections	55
Autotest in Smart Remote Mode	55
Step 1: Set the Reference in Smart Remote Mode	57

Step 2: Measure the Loss of the Test Reference Cords You Will Add	59
Step 3: Do an Autotest in Smart Remote Mode	60
Autotest Results for Smart Remote Mode	61
Fiber IDs for Saved Results in Smart Remote Mode	61
Autotest in Loopback Mode	64
Step 1: Set the Reference in Loopback Mode	66
Step 2: Measure the Loss of the Test Reference Cord You Will Add	68
Step 3: Do an Autotest in Loopback Mode	69
Autotest Results for Loopback Mode	70
Autotest in Far End Source Mode	72
Auto Wavelength Modes	72
Step 1: Set the Reference in Far End Source Mode	74
Step 2: Measure the Loss of the Test Reference Cord You Will Add	77
Step 3: Do an Autotest in Far End Source Mode	77
Autotest Results for Far End Source Mode	78
Bi-Directional Tests	80
Chapter 4 The FiberInspector Test	
How to Do the FiberInspector Test	83
Chapter 5 The Visual Fault Locator	
Visual Fault Locator Applications	89
How to Use the VFL	90
Chapter 6 The Power Meter and Light Source	
How to Monitor Power and Loss	93

How to Control the Light Source	97
Use the Display to Control the Main Tester's Light Source	98
Use the Module's Button to Control the Light Source	98

Chapter 7 Test Results

View Saved Results	101
How to Add a Result to a Saved Result	104
How to Replace a Saved Result that Failed	105
Delete, Rename, and Move Results	106
Manage Results on a Flash Drive	107
Upload Results to a PC	108
View the Memory Status	110

Chapter 8 Projects

Why Use Projects?	111
Set Up a Project	112
The PROJECT Screen	112
The CABLE ID SETUP Screen	115
About Next ID Sets	115
Manage Projects on a Flash Drive	118
Copy Project Settings to Other Testers	119

Chapter 9 Maintenance

Maintenance	121
Verify Operation	122
Clean the Tester	122
Clean the DI-1000 Video Probe	122
Traceable Calibration Period	123

See Information About the Tester 123

Update the Software 123

Extend the Life of the Battery 128

Store the Tester 128

Remove the Battery 128

Calibration 129

If the Tester Does Not Operate as Usual 129

Options and Accessories 130

Certifications and Compliance 131

Regulatory Information 131

Appendix A: Reference Method Names

Appendix B: Modified 1 Jumper Reference Method

List of Figures

Figure		Page
1.	Main Tester Connectors, Keys, and LEDs (CFP-QUAD module shown)	10
2.	Remote Tester Connectors, Keys, and LEDs (CFP-QUAD module shown)	12
3.	The Home Screen for CertiFiber Pro Modules.....	15
4.	LEDs Show the Remote's Battery Status.....	19
5.	Connections to See the Status of the Remote's Battery	20
6.	How to Zoom the Screen.....	22
7.	FIX LATER, TEST AGAIN, and TEST Buttons and the TEST Key.....	24
8.	How to Remove and Install the Connector Adapters...	28
9.	How to Install a Strap and Use the Hand Strap	29
10.	How to Remove and Install a Module	30
11.	Examples of Clean and Dirty Fiber Endfaces.....	33
12.	Equipment to Clean and Inspect Fiber Endfaces	35
13.	How to Use the IBC OneClick Cleaner	37
14.	How to Prevent Damage to the EF-TRC Fiber Cables ...	46
15.	Screen to Set the Number of Connectors, Splices, and Jumpers.....	52
16.	How to Count the Numbers of Connectors, Splices, and Jumpers.....	54
17.	Equipment for Autotests in Smart Remote Mode	56
18.	Connections for Smart Remote Mode (1 Jumper Reference, Multimode Fiber).....	58

19.	Result for Smart Remote Mode (Unsaved Bi-Directional Results Shown)	62
20.	Equipment for Autotests in Loopback Mode.....	65
21.	Connections for Loopback Mode (1 Jumper Reference, Multimode Fiber).....	67
22.	Result for Loopback Mode	70
23.	Equipment for Autotests in Far End Source Mode	73
24.	Connections for Far End Source Mode (1 Jumper Reference Multimode Fiber).....	76
25.	Result for Far End Source Mode	79
26.	Equipment for the FiberInspector Test	83
27.	FiberInspector Image with Measurement Scales (fiber with 50 μm core shown)	86
28.	Equipment for Visual Fault Locator Tests	90
29.	How to Use the Visual Fault Locator	92
30.	Equipment for Power Meter Measurements	94
31.	Connections to Monitor Power and Loss	95
32.	Power Meter Measurements and Controls	96
33.	Light Source Controls for the Main Tester	99
34.	RESULTS Screen.....	102
35.	How to Connect the Tester to a PC	109
36.	PROJECT Screen	113
37.	CABLE ID SETUP Screen (after you enter the first and last IDs).....	116
38.	How to Connect the Tester to a PC	125
39.	How to Connect Units Together to Update the Software	127
40.	How to Remove the Battery	129
B-1.	Modified 1 Jumper Reference Method for Smart Remote Mode	136

Chapter 1: Get Acquainted

Overview of the CertiFiber Pro Optical Loss Test Set Modules

The Fluke Networks CertiFiber® Pro Optical Loss Test Set (OLTS) modules attach to Versiv™ main and remote units to make rugged, hand-held testers that let you certify, troubleshoot, and document optical fiber cabling installations. The testers include these features:

- Measures optical power loss and length on dual-fiber, multimode cabling at 850 nm and 1300 nm (CFP-MM) or on dual-fiber singlemode cabling at 1310 nm and 1550 nm (CFP-SM). The four-wavelength module (CFP-QUAD) measures at 850 nm, 1300 nm, 1310 nm, and 1550 nm.
- Interchangeable connector adapters on input and output ports let you make reference and test connections that agree with ISO standards for most SFF (small form factor) connectors.
- Visual fault locator helps you find breaks, bad splices, and bends and verify fiber continuity and polarity.
- You can save approximately 30,000 fiber test results in the tester's internal memory. You can save more results on a removable flash drive.

Contact Fluke Networks



www.flukenetworks.com



support@flukenetworks.com



+1-425-446-4519



Fluke Networks

PO Box 777

Everett, WA 98206-0777

USA

- Australia: 61 (2) 8850-3333 or 61 (3) 9329 0244
- Beijing: 86 (10) 6512-3435
- Brazil: 11 3759 7600
- Canada: 1-800-363-5853
- Europe: +31-(0) 40 2675 600
- Hong Kong: 852 2721-3228
- Japan: 03-6714-3117
- Korea: 82 2 539-6311
- Singapore: +65-6799-5566
- Taiwan: (886) 2-227-83199
- USA: 1-800-283-5853

Visit our website for a complete list of phone numbers.

Register Your Product

Registering your product with Fluke Networks gives you access to valuable information on product updates, troubleshooting tips, and other support services. To register, fill out the online registration form on the Fluke Networks website at www.flukenetworks.com.

Technical Reference Handbook

The *Versiv Technical Reference Handbook* has more information about the tester. The Handbook is on the Versiv Product Manuals CD included with your product, and on the Fluke Networks website.

Additional Resources

The Fluke Networks Knowledge Base answers common questions about Fluke Networks products and provides articles on cable testing techniques and technology.

To access the Knowledge Base, log on to www.flukenetworks.com, then click **SUPPORT > Knowledge Base**.

Supplements and Updated Manuals

If necessary, Fluke Networks will put a supplement for this manual, or an updated manual, on the Fluke Networks website. To see if a supplement or updated manual is available, log on to www.flukenetworks.com, click **SUPPORT > Manuals**, then select a product.

Kit Contents

The CertiFiber Pro kits come with the accessories in the lists below. If something is damaged or missing, contact the place of purchase immediately.

CFP-100-M Kit

- Versiv main and remote units with battery packs
- Two CertiFiber Pro Multimode Optical Loss Test Set (OLTS) Modules for tests at 850 nm and 1300 nm
- Two encircled flux test reference cords (EF-TRCs) for 50 μm /125 μm fiber, SC/LC connectors
- Two test reference cords for 50 μm /125 μm fiber, LC/LC
- Two LC/LC adapters
- Carrying case for the testers
- Case for the test reference cords
- Two hand straps for the testers
- USB cable for PC communications, type A USB to Micro-B USB
- Two AC adapter/chargers
- CertiFiber Pro Getting Started Guide
- Versiv Product Manuals CD
- LinkWare Software CD

CFP-100-S Kit

- Versiv main and remote units with battery packs
- Two CertiFiber Pro Singlemode Optical Loss Test Set (OLTS) Modules for tests at 1310 nm and 1550 nm
- Two test reference cords for singlemode fiber, SC/LC
- Two test reference cords for singlemode fibers, LC/LC
- Two LC/LC adapters
- Carrying case for the testers
- Case for the test reference cords
- Two hand straps for the testers

- USB cable for PC communications, type A USB to Micro-B USB
- Two AC adapter/chargers
- CertiFiber Pro Getting Started Guide
- Versiv Product Manuals CD
- LinkWare Software CD

CFP-100-Q Kit

- Versiv main and remote units with battery packs
- Two CertiFiber Pro Quad Optical Loss Test Set (OLTS) Modules for tests at 850 nm, 1300 nm, 1310 nm and 1550 nm
- Two encircled flux test reference cords (EF-TRCs) for 50 μm /125 μm fiber, SC/LC
- Two test reference cords for 50 μm /125 μm fiber, LC/LC
- Two test reference cords for singlemode fiber, SC/LC
- Two test reference cords for singlemode fiber, LC/LC
- Two LC/LC adapters
- Carrying case for the testers
- Case for the test reference cords
- Two hand straps for the testers
- USB cable for PC communications, type A USB to Micro-B USB
- Two AC adapter/chargers
- CertiFiber Pro Getting Started Guide
- Versiv Product Manuals CD
- LinkWare Software CD

CFP-Q-ADD Kit





- Two CertiFiber Pro Quad Optical Loss Test Set (OLTS) Modules for tests at 850 nm, 1300 nm, 1310 nm and 1550 nm
- Two encircled flux test reference cords (EF-TRCs) for 50 μm /125 μm fiber, SC/LC
- Two test reference cords for 50 μm /125 μm fiber, LC/LC
- Two test reference cords for singlemode fiber, SC/LC
- Two test reference cords for singlemode fiber, LC/LC
- Two LC/LC adapters
- Carrying case for the testers
- Case for the test reference cords
- CertiFiber Pro Getting Started Guide
- Versiv Product Manuals CD

⚠ Safety Information

Table 1 shows the international electrical symbols used on the tester or in this manual. Symbols for certifications and compliance are on page 131.

Ⓞ: This key turns the tester on and off.

Table 1. International Electrical Symbols

	Warning: Risk of fire, electric shock, or personal injury.
	Warning or Caution: Risk of damage or destruction to equipment or software. See explanations in the manuals.
	Warning: Class 1 (OUTPUT port) and Class 2 (VFL port) lasers. Risk of eye damage from hazardous radiation.
	Do not put products containing circuit boards into the garbage. Dispose of circuit boards in accordance with local regulations.

Warning

To prevent possible fire, electric shock, or personal injury:

- Use only AC adapters approved by Fluke Networks for use with the tester to supply power to the tester and charge the battery.
- Do not put the battery pack in a fire or an environment with temperatures more than 140 °F (60 °C).
- Do not use the tester in damp or wet environments.
- Do not short-circuit or disassemble the battery pack.
- Do not use the tester if it is damaged. Inspect the tester before use.
- Do not open the case; no user-serviceable parts are inside.
- Do not modify the tester.

- If this equipment is used in a manner not specified by the manufacturer, the protection provided by the equipment can possibly be impaired.

 **Warning: Class 1 and Class 2 Laser Products** 

To prevent possible eye damage caused by hazardous radiation:

- Do not look directly into optical connectors. Some optical equipment emits invisible radiation that can cause permanent damage to your eyes.
- Keep the module's OUTPUT ports covered with a dust cap or keep a test reference cord attached. The OUTPUT ports can emit radiation even when you do not do a test.
- Do not run any tests that activate the outputs on the tester unless a fiber is attached to the output.
- When you inspect fiber endfaces, use only magnification devices that have the correct filters.
- Use of controls, adjustments, or procedures not stated herein can possibly result in hazardous radiation exposure.

 **Caution**

To prevent damage to the tester or cables under test and to prevent data loss:

- Do not connect the tester to an active network. Doing so causes unreliable test results, can disrupt network operations, and can cause damage to the module's receiver.
- Use proper cleaning procedures to clean all fiber connectors before every use. Neglecting this step or using improper procedures can cause unreliable test results and may permanently damage the connectors. See Chapter 6.

- Use a video probe to periodically inspect the module's optical connectors for scratches and other damage.
- To make sure your test results are as accurate as possible, do the reference procedure frequently. See "About the Reference for Fiber Tests" on page 42.
- Use only high-quality test reference cords that comply with the standards. See "About Test Reference Cords and Mandrels" on page 44
- Connect the AC adapter or replace the battery as soon as the low battery indication appears.
- Keep modules attached to the main and remote Versiv units to give protection to the module connectors.
- Do not remove the USB flash drive while the LED on the drive flashes. Doing so can corrupt the data on the drive.
- You can lose a USB flash drive, cause damage to it, or accidentally erase the contents of the drive. Thus, Fluke Networks recommends that you save no more than one day of test results on a flash drive.

Connectors, Keys, and LEDs

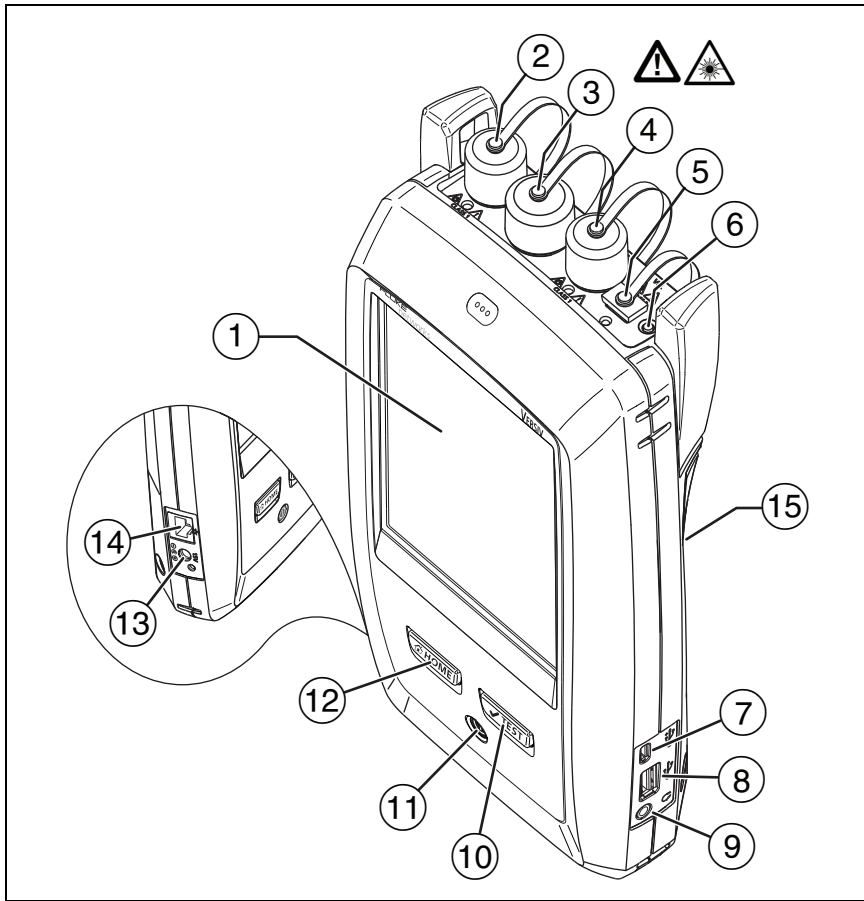

GPU123.EPS





Figure 1. Main Tester Connectors, Keys, and LEDs (CFP-QUAD module shown)

- ① LCD display with touchscreen
- ② Singlemode output port with removable connector adapter and dust cap. This port transmits optical signals for loss and length measurements.

The LED below the output port is red when the port transmits 1310 nm and green for 1550 nm.

- ③ Input port with removable connector adapter and dust cap. This port receives optical signals for loss, length, and power measurements.
- ④ Multimode output port with removable connector adapter and dust cap. This port transmits optical signals for loss and length measurements.

The LED below the output port is red when the port transmits 850 nm and green for 1300 nm.

- ⑤ Universal fiber connector (with dust cap) for the visual fault locator. The connector accepts 2.5 mm ferrules. The LED below the connector shows the locator's mode.
- ⑥ Button to manually control the output ports (② and ④) and the visual fault locator (⑤).
- ⑦ Micro-AB USB port: This USB port lets you connect the tester to a PC so you can upload test results to the PC and install software updates in the tester.
- ⑧ Type A USB port: This USB host port lets you save test results on a USB flash drive or connect a video probe to the tester.
- ⑨ Headset jack
- ⑩  TEST: Starts a test. To start a test, you can also tap **TEST** on the display.
- ⑪ : Power key
- ⑫  HOME: Press  HOME to go to the home screen.
- ⑬ Connector for the AC adapter. The LED is red when the battery charges, and green when the battery is fully charged. The LED is yellow if the battery will not charge. See “Charge the Battery” on page 18.
- ⑭ RJ45 connector: For functions available in future software releases.

- ⑮ Decal with laser safety information.

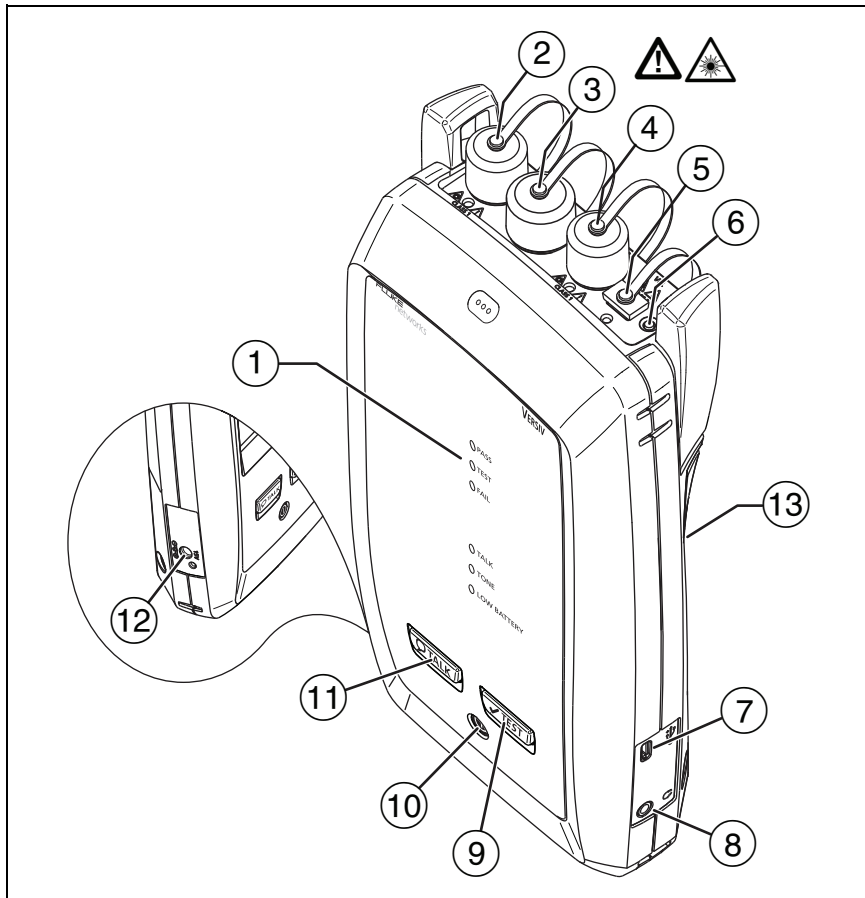

GPU136.EPS

Figure 2. Remote Tester Connectors, Keys, and LEDs (CFP-QUAD module shown)

- ① **PASS** LED comes on when a test passes.

TEST LED comes on during a test.

FAIL LED comes on when a test fails.

TALK LED comes on when the talk function is on.

LOW BATTERY LED comes on when the battery is low.

The LEDs also have these functions:

- Battery gauge (see Figure 4 on page 19)
- Volume indicator for the **TALK** function
- Progress indicator for software updates

- ② Singlemode output port with removable connector adapter and dust cap. This port transmits optical signals for loss and length measurements.

The LED below the output port is red when the port transmits 1310 nm and green for 1550 nm.

- ③ Input port with removable connector adapter and dust cap. This port receives optical signals for loss, length, and power measurements.

- ④ Multimode output port with removable connector adapter and dust cap. This port transmits optical signals for loss and length measurements.





The LED below the output port is red when the port transmits 850 nm and green for 1300 nm.

- ⑤ Universal fiber connector (with dust cap) for the visual fault locator. The connector accepts 2.5 mm ferrules. The LED below the connector shows the locator's mode.

- ⑥ Button to manually control the output ports (② and ④) and the visual fault locator (⑤).

- ⑦ Micro-AB USB port: This USB port lets you connect the tester to a PC so you can install software updates in the tester.

- ⑧ Headset jack

- 9 : Starts a test.
- 10 : Power key
- 11 : Press  to use the headset to speak to the person at the other end of the link. Press again to adjust the volume. To turn off the talk function, hold down .
- 12 Connector for the AC adapter. The LED is red when the battery charges, and green when the battery is fully charged. The LED is yellow if the battery will not charge. See “Charge the Battery” on page 18.
- 13 Decal with laser safety information.



The Home Screen for CertiFiber Pro Modules

The home screen (Figure 3) shows important test settings. Before you do a test, make sure these settings are correct.





GPU117.EPS

Figure 3. The Home Screen for CertiFiber Pro Modules

- ① **PROJECT:** The project contains the settings for a job and helps you monitor the status of a job. When you save test results, the tester puts them in the project. Tap the **PROJECT** panel to edit the project settings, select a different project, or make a new project.

- ② Shows a summary of the test results in the project:

 The number of tests that passed.

 The number of tests that failed.

- ③ The test setup panel shows the settings the tester will use when you tap **TEST** or press .

To change these settings, tap the panel, select the test on the **CHANGE TEST** screen, tap **EDIT**, select different settings on the **TEST SETUP** screen, then tap **SAVE**. See Table 2 on pages 49 and 50.

Note



You can set up tests for any module that the tester can use, even when no module is attached.

- ④ **Next ID:** The **Next ID** panel shows the ID that the tester gives to the next test results you save. For **Smart Remote** mode, this panel shows IDs for main tester's input and output fibers.

Tap **Next ID** to do these tasks:

- Enter an ID, select a different ID in the ID set, select a different set of IDs, or make a new set. The tester adds the IDs and ID sets you make to the project that shows on the home screen.
- Turn **Auto Save** on or off.

- ⑤ **Operator:** The name of the person who does the job. You can enter a maximum of 20 operator names.
- ⑥ **TOOLS:** The **TOOLS** menu lets you set the reference for fiber tests, see the status of the tester, and set user preferences such as the language and the display brightness.
- ⑦ **SET REF:** Tap **SET REF** to set the reference and verify your test reference cords for loss/length tests.
- ⑧ **RESULTS:** Tap **RESULTS** to see and manage the results that are saved in the tester.

- ⑨ **TEST:** Tap **TEST** to do the test shown in the test setup panel.
- ⑩ The percentage of the tests in the project that are completed. The tester uses the number of available IDs to calculate this percentage. See Figure 37 on page 116. % **Tested** does not show if your project contains only a **Next ID** list. See “About Next ID Sets” on page 115 for more information about the **Next ID** list.
- ⑪ The type of module attached to the tester.
- ⑫  This icon shows when the input and output ports on the tester’s CertiFiber Pro module are connected to the ports on the remote’s CertiFiber Pro module and the remote tester is turned on.
- ⑬  This icon shows when the talk function is on. To use the talk function:
 - 1 Connect the main and remote testers together through a duplex fiber link.
 - 2 Connect headsets to the headset jacks on the testers
 - 3 Press the button on one of the headset microphones or press  on the remote, then speak into the microphone.

AC Adapter and Battery

You can use the AC adapter (model VERSIV-ACUN) or the lithium ion battery (model VERSIV-BATTERY) to supply power to the tester.

To remove the battery, see “Remove the Battery” on page 128.

Charge the Battery

Before you use the battery for the first time, charge the battery for about 2 hours with the tester turned off.

To charge the battery

Connect the AC adapter to the tester. See item ⑬ in Figure 1. The LED near the AC adapter connector is red when the battery charges, and green when the battery is fully charged.

A fully-charged battery operates for approximately 8 hours of typical use. The battery takes approximately 4 hours to fully charge when the tester is turned off.

Notes

You do not need to fully discharge the battery before you recharge it.

The battery will not charge if its temperature is outside the range of 32 °F to 104 °F (0 °C to 40 °C). The LED near the connection for the AC adapter is yellow if the battery will not charge.

Check the Battery Status

On a main tester

The battery status icon is in the upper-left corner of the screen:



Battery is full.



Battery is approximately half full.

 If the AC adapter is not connected, the red bar shows that the battery is very low. Connect the AC adapter to charge the battery and make sure the tester continues to operate.

The red bar also shows if the AC adapter is connected, but the battery is not installed.

On a remote

The LEDs show the battery status at the end of the power-up sequence, as shown in Figure 4.

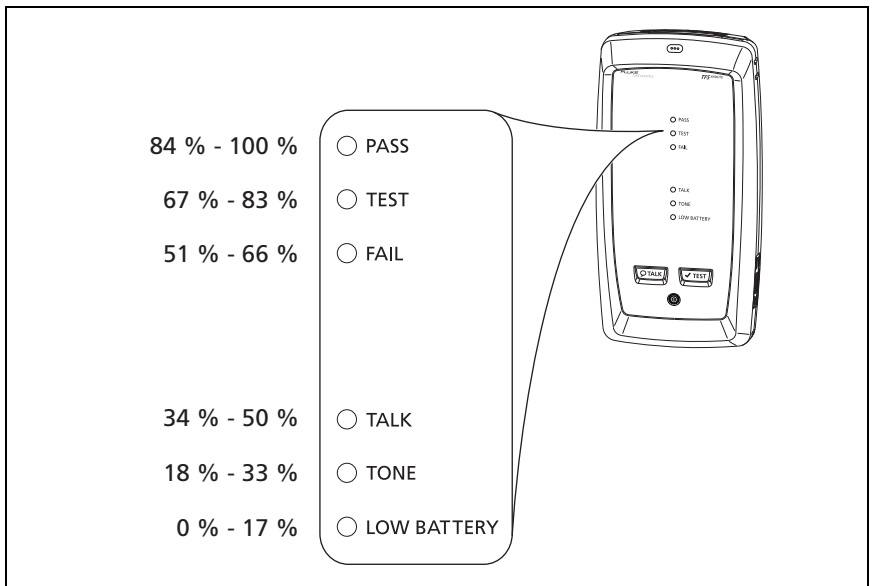

GPU102.EPS

Figure 4. LEDs Show the Remote's Battery Status

To see more information about the battery status

- 1 Make the connections shown in Figure 5 and turn on both testers.
- 2 Tap **TOOLS**, then tap **Battery Status**.

When the AC adapter is not connected, the screen shows the **Time Remaining**, which is the approximate battery life at the present rate of use.

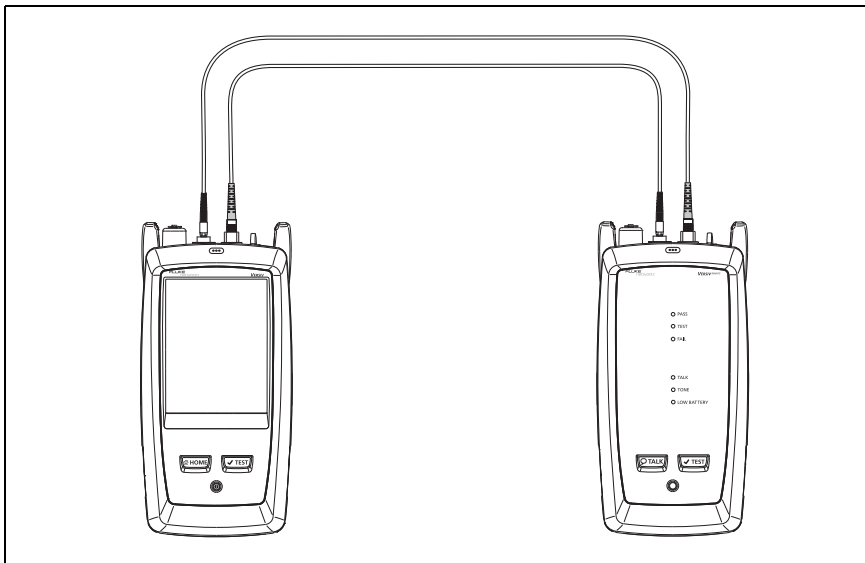

GPU134.EPS

Figure 5. Connections to See the Status of the Remote's Battery

How to Use the Touchscreen

The touchscreen lets you use fingertip gestures to control the tester. You can also operate the touchscreen with a stylus that is made for projected capacitance touchscreens.

Caution

For correct operation and to prevent damage to the touchscreen:

- **Touch the screen only with your fingers or with a stylus that is made for projected capacitance touchscreens. Do not use too much force.**
- **Do not touch the screen with sharp objects.**

Note

The touchscreen will not respond if you tap it with your fingernail or an incorrect type of stylus or if you wear non-conductive gloves.

To use the touchscreen

- To select an item on the screen, tap the item lightly with your fingertip.
- To scroll a screen, lightly touch the screen then move your fingertip in the direction you want the screen to move.
- On FiberInspector screens, use the pinch and reverse-pinch gestures to change the magnification on the screen. See Figure 6.

To clean the touchscreen, turn off the tester, then use a soft, lint-free cloth that is moist with a mild detergent.

Caution

When you clean the touchscreen, do not let liquid get under the plastic around the touchscreen.

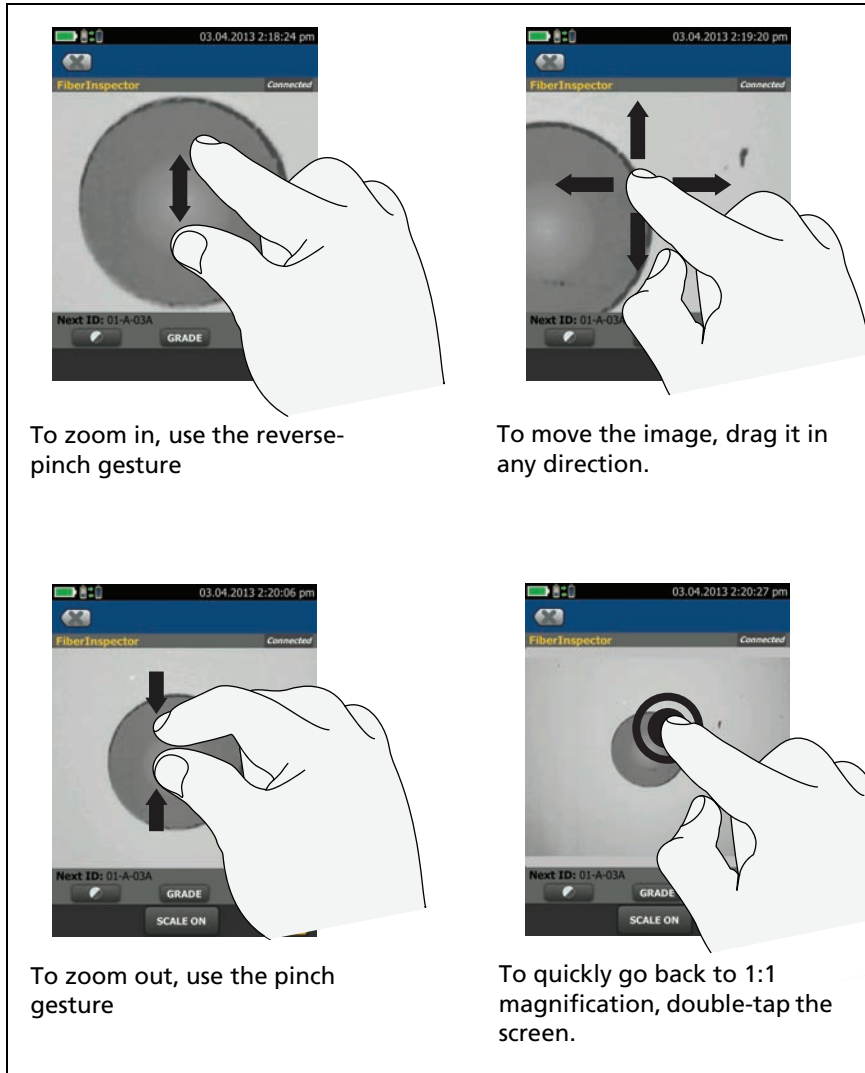

Figure 6. How to Zoom the Screen

HGD45.EPS

Verify Operation

The tester does a self test when you turn it on. If the tester shows an error or does not turn on, refer to “If the Tester Does Not Operate as Usual” on page 129.

Change the Language

On the home screen, tap the **TOOLS** icon, tap **Language**, then tap a language.

Buttons to Do Tests and Save Results

When a test is completed and more than one button shows at the bottom of the screen, the tester highlights one in yellow to recommend which one to tap. Figure 7 shows the buttons you will see.

Note

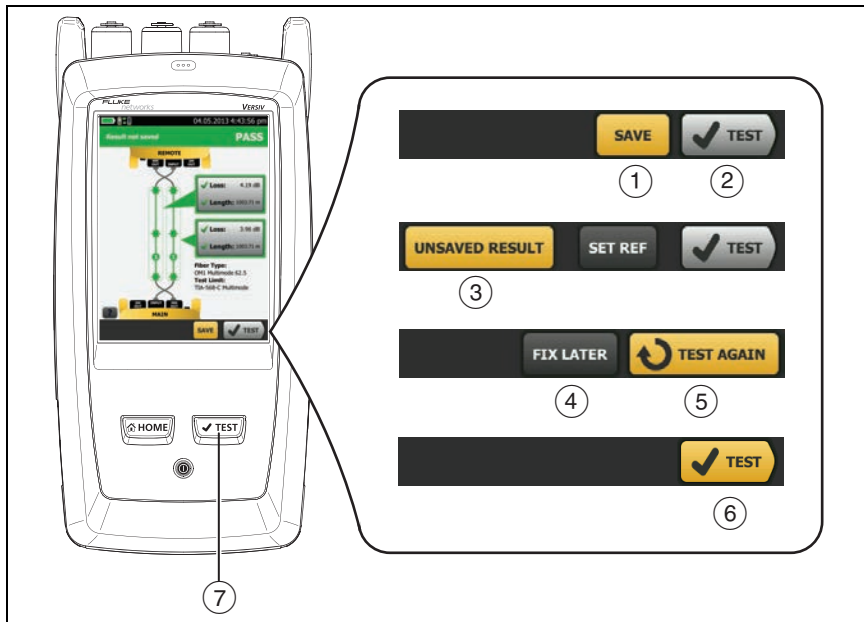

*To change the **Auto Save** setting, tap the **Next ID** panel on the home screen.*



HGD40.EPS

Figure 7. FIX LATER, TEST AGAIN, and TEST Buttons and the TEST Key

- ① **SAVE** (yellow), ② **TEST** (gray): These buttons show if the test passed and **Auto Save** is off. When you tap **SAVE**, you can save the results with an ID that you make or select. When you tap **TEST**, you can select to save the results or do the test again and not save the results.
- ③ **UNSAVED RESULT**: This button shows if **Auto Save** is off and you go to the home screen when a test is completed. Tap this button to see the result.
- ④ **FIX LATER**: This button shows if the test failed and **Auto Save** is off. Tap **FIX LATER** to save the results with an ID that you make or select.

- ⑤ **TEST AGAIN:** This button shows if the test failed. Tap this button to do the test again for the same ID. If **Auto Save** is on, the tester saves subsequent results with the same ID. If **Auto Save** is off, you can save the result if necessary. When you look at a saved result that failed, tap **TEST AGAIN** to do the test again for the same ID and with the same test settings as the saved result.
- ⑥ **TEST (yellow):** This button shows if the test passed and **Auto Save** is on. When **Auto Save** is on, the tester saves results with the next available ID when the test is completed. When you tap **TEST**, the tester does a test for the next available ID.
- ⑦ : Press  to do the test shown on the home screen for the **Next ID**.

Overview of Memory Functions

You can save approximately 30,000 fiber Autotest results.

The capacity available for test results depends on the space used by the software and custom test limits in the tester.

To see the memory status

On the home screen, tap the **TOOLS** icon, then tap **Memory Status**.

To make more memory available, you can export results to a USB flash drive, then delete the results in the tester. See “Manage Results on a Flash Drive” on page 107.

Options for Cable IDs

When you save the test results for a cable, you usually give the results the name that is the ID for the cable. There are several methods you can use to make IDs for test results:

- You can use the **CABLE ID SETUP** screen to make a set of sequential IDs. The tester uses the IDs in sequence as the names for the results you save. When **Auto Save** is on, the tester automatically saves each result with the next available ID in the set. See Chapter 8.

A cable ID set also lets you use IDs again so you can add different results to tests you saved before.

- You can enter an ID each time you do a test. To do this, turn off the **Auto Save** function (see page 27). Each time a test is completed, tap **SAVE** (if the test passed) or **FIX LATER** (if the test failed), then enter an ID manually.
- You can use LinkWare software to make a set of IDs, download the set to the tester, then import it into a project.
- After you do a test, you can enter the ID for a test you saved before. This lets you replace results or add different results to a test you saved before.
- If the test failed before, and you saved the results, you can select it on the **RESULTS** screen, then press **TEST AGAIN** to replace the results for that ID.

Notes

Cable IDs are case-sensitive. For example, the tester saves result with the names "A0" and "a0" in two different records.

A cable ID can have a maximum of 60 characters.

If you delete all the ID sets in a project, the tester makes a default set that starts with 001.

To turn the Auto Save function on or off

- 1 On the home screen, tap the **Next ID** panel.
- 2 On the **CHANGE ID** screen, tap the **On/Off** control next to **Auto Save**.
- 3 Tap **DONE**.

How to Remove and Install the Connector Adapters

You can change the connector adapters on the input ports of the modules to connect to SC, ST, LC, and FC fiber connectors. You can remove the adapter on the output port to clean the fiber endface in the port. See Figure 8.

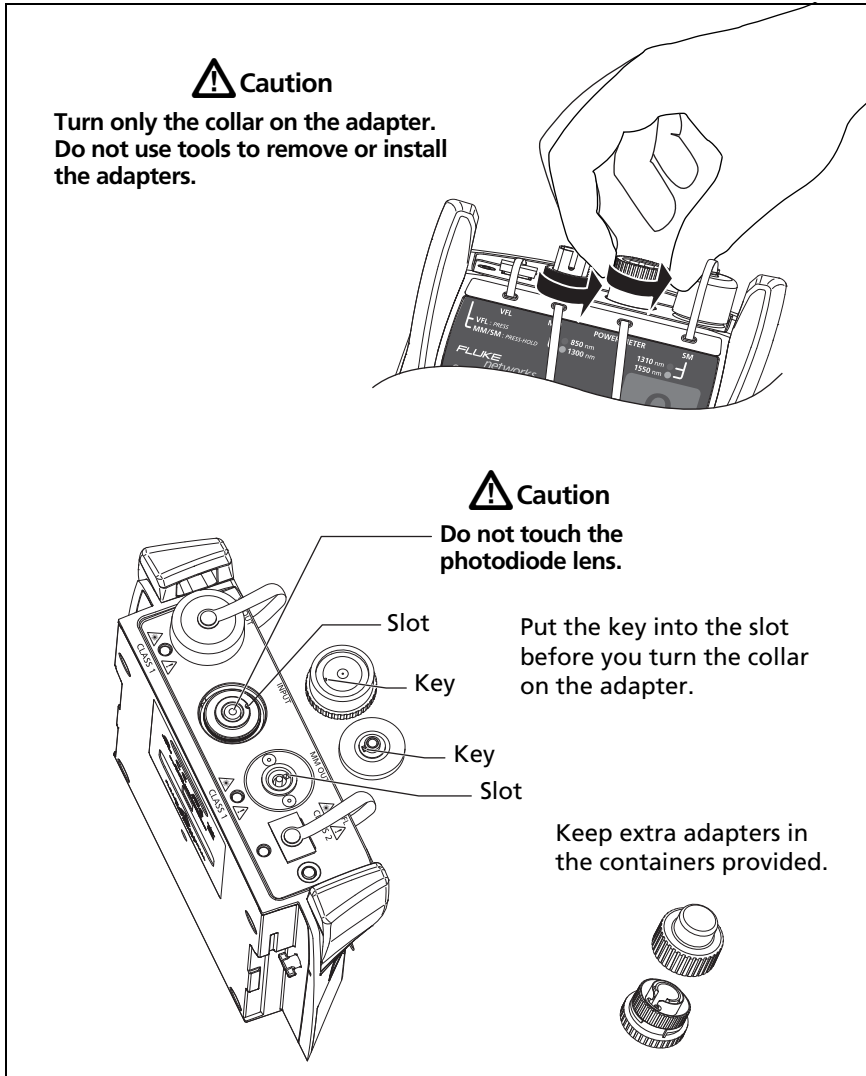
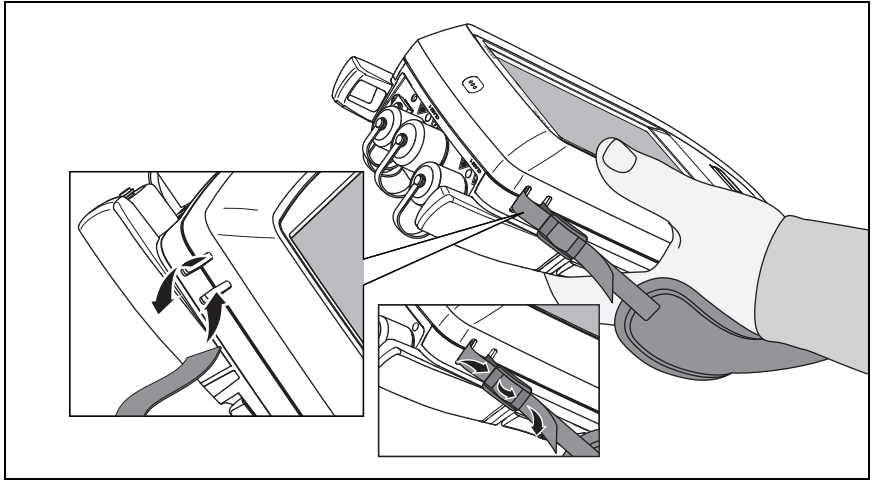

Figure 8. How to Remove and Install the Connector Adapters

How to Install a Strap

Two types of straps are available for the tester: a hand strap that helps you hold the tester, and an optional carrying strap that lets you carry and hang the tester. Figure 9 shows how to install a strap and how to use the hand strap.



HGD43.EPS

Figure 9. How to Install a Strap and Use the Hand Strap

How to Remove or Install a Module

Figure 10 shows how to remove and install the module.

Note

It is not necessary to turn off the tester before you remove or install a module.

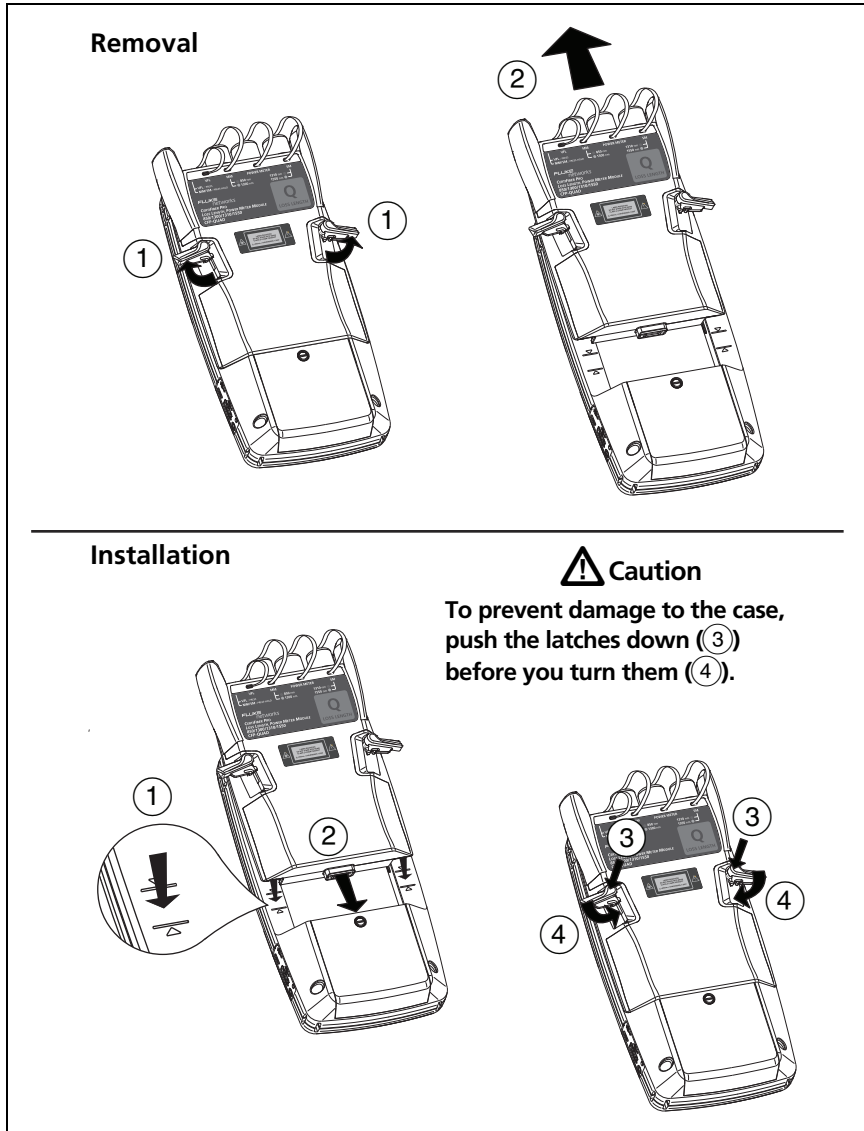

Figure 10. How to Remove and Install a Module

About LinkWare and LinkWare Stats Software

The LinkWare Cable Test Management software included with your tester lets you upload test records to a PC, organize and examine test results, print professional-quality test reports, and do software updates and other maintenance procedures on your tester.

Updates to LinkWare software are available on the Fluke Networks website.

The LinkWare Stats Statistical Report software that is included with LinkWare software provides statistical analysis of cable test reports and generates browsable, graphical reports.

For instructions about LinkWare and LinkWare Stats software, see the guides for getting started and the online help available under **Help** on the LinkWare and LinkWare Stats menus.

Chapter 2: How to Clean Fiber Endfaces

When a fiber optic link does not operate correctly, the cause is frequently a dirty endface in a connector. Figure 11 shows examples of dirty endfaces and an endface that has been correctly cleaned and polished.

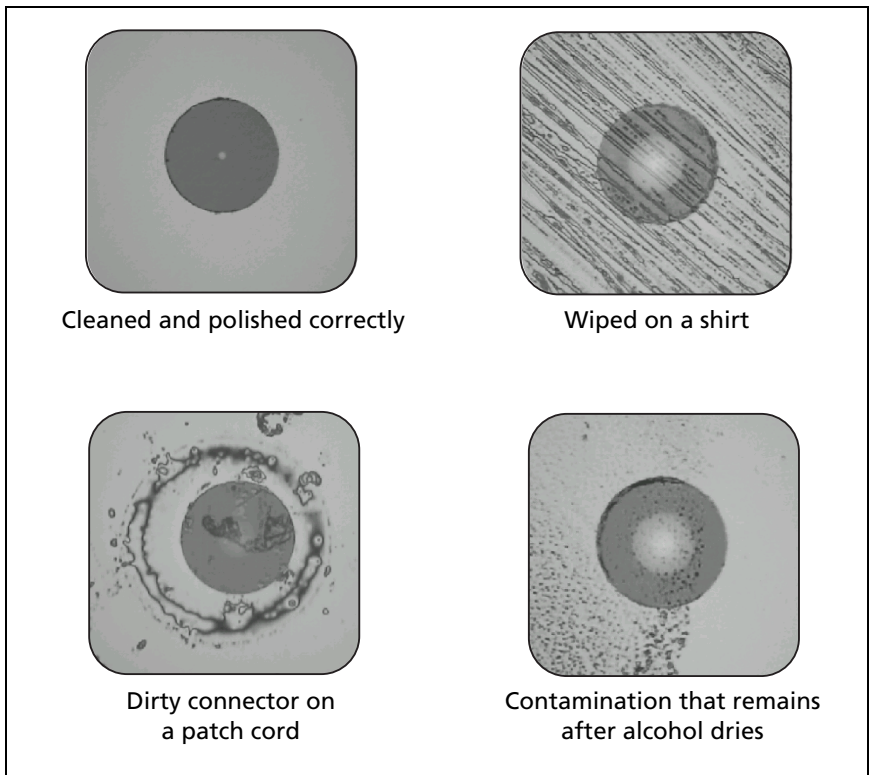

GPU36.EPS

Figure 11. Examples of Clean and Dirty Fiber Endfaces

Always clean and inspect the endfaces in fiber connectors before you make connections. Fluke Networks recommends that you use a mechanical device, such as the Fluke Networks IBC OneClick Cleaner, to clean connectors. If you do not have such a device, or if the device does not clean the connector sufficiently, use other optical-grade supplies to clean connectors.

Figure 12 shows the equipment you use to clean and inspect fiber endfaces.

 **Warning** 

To prevent possible eye damage caused by hazardous radiation:

- Do not look directly into optical connectors. Some optical equipment emits invisible radiation that can cause permanent damage your eyes.
- Before you clean an endface, turn off any optical sources (laser or LED) that are connected to the fiber.
- When you inspect endfaces, use only magnification devices that have the correct filters.

 **Caution**

To prevent damage to connectors and to keep contamination off of endfaces:

- Always cover unused connectors and adapters with protective caps.
- Always keep unused protective caps in a clean, sealed container to prevent contamination.

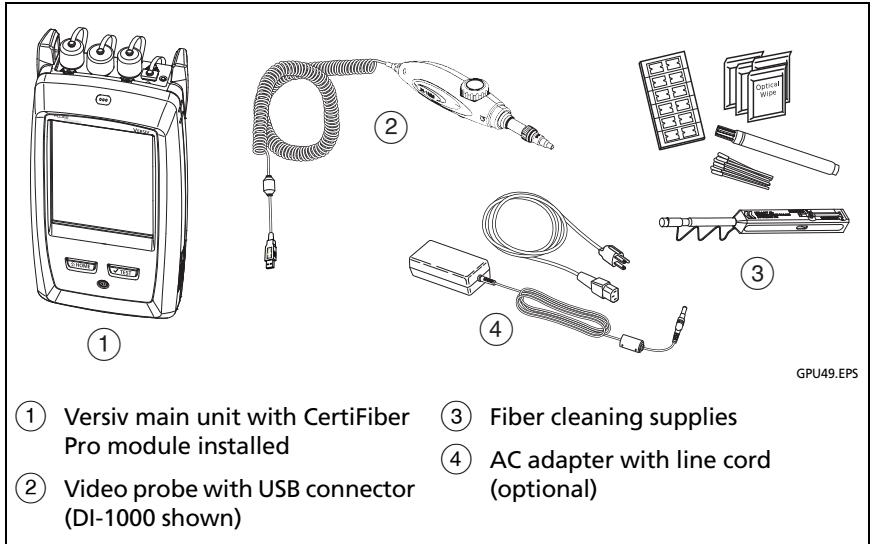

Figure 12. Equipment to Clean and Inspect Fiber Endfaces

How to Use a Fluke Networks IBC OneClick Cleaner

Caution

To prevent damage to the device and to connectors and to keep contamination off of endfaces, read all instructions and obey all safety precautions given in the instructions for the device you use to clean connectors.

To clean the connectors on test reference cords, use wipes and solvent. The OneClick cleaner cleans the fiber core, but can leave contamination around the core. The contamination can move to the core when you make connections. See “To Clean Connector Ends” on page 39.

- 1 Use the video probe to inspect the connector. If it is dirty, continue to step 2.
- 2 To clean a bulkhead connector, remove the cap. To clean the connector on a fiber cable, remove only the tip of the cap.
- 3 If necessary for a bulkhead connector, extend the tip of the device.
- 4 Push the device straight into the connector until you hear a loud click. See Figure 13. Then remove the device.
- 5 Use the video probe to inspect the connector. If necessary, clean and inspect the connector again.

If the mechanical device does not clean the connector sufficiently, use a swab and solvent to clean the connector.

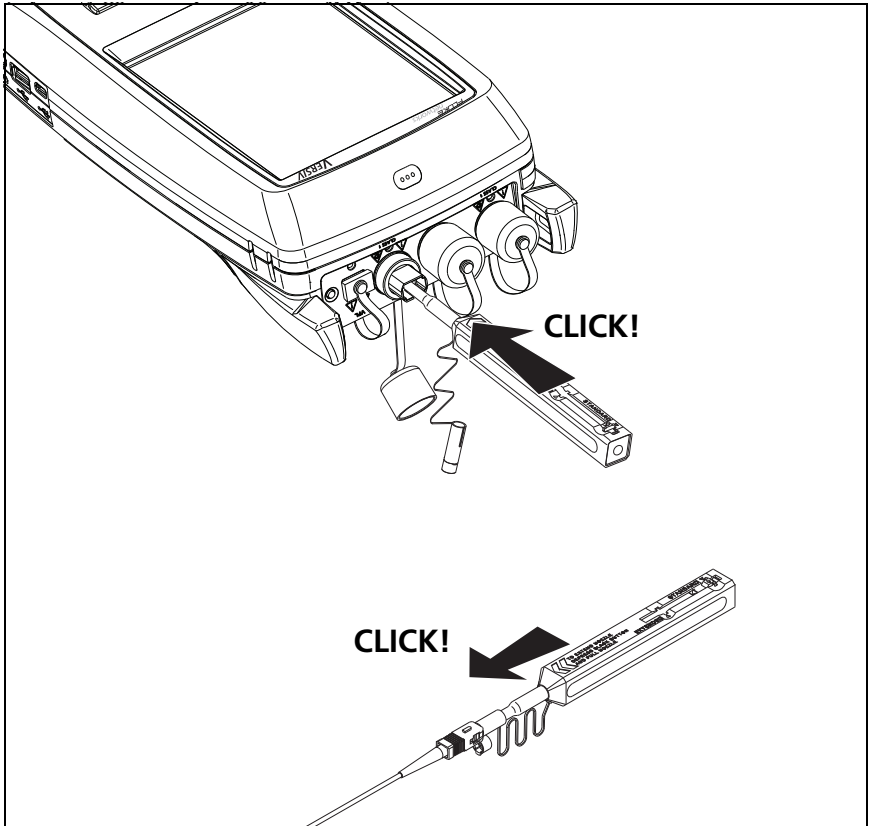

GPU16.EPS

Figure 13. How to Use the IBC OneClick Cleaner

How to Use Wipes, Swabs, and Solvent

Caution

To prevent damage to connectors and to keep contamination off of endfaces:

- Always discard wipes or swabs after you use them.
- Do not let solvent dry on an endface. Some solvents leave a residue after they dry.
- If you must use alcohol as a solvent, make sure you use 99%-pure, anhydrous alcohol.

To Clean Bulkhead Connectors

- 1 Use a video probe to inspect the connector. If it is dirty, continue to step 2.
- 2 Touch the tip of a fiber optic solvent pen or swab soaked in solvent to a lint-free dry wipe or fiber cleaning card.
- 3 Touch a new, dry swab to the solvent spot on the wipe or card. Push the swab into the connector, twist it around 3 to 5 times against the end-face, then remove and dispose of the swab.
- 4 Dry the connector with a dry swab by twisting it around in the connector 3 to 5 times.
- 5 Use a video probe to inspect the connector. If necessary, clean and inspect the connector again.

To Clean the Optical Connectors on the Modules

To clean the optical connectors on the modules, first use the procedure given under “To Clean Bulkhead Connectors”.

If a connector is very dirty or the procedure above does not make it clean, use this procedure:

- 1 Unscrew the adapter on the connector.
- 2 Clean the ferrule or photodiode lens with a dry, optical-grade wipe made for fiber optic connectors.
- 3 Use a video probe to inspect the connector. If necessary, clean and inspect the connector again.
- 4 If the connector stays dirty, use a wipe that is moist with optical-grade solvent to clean the endface. Dry the ferrule or lens with a dry wipe.

To Clean Fiber Adapters

At regular intervals, clean fiber adapters with a swab and fiber optic solvent. Dry with a dry swab.

To Clean Connector Ends

- 1 Use a video probe to inspect the connector. If it is dirty, continue to step 2.
- 2 Touch the tip of a fiber optic solvent pen or swab soaked in solvent to a lint-free dry wipe or fiber cleaning card.
- 3 Wipe the connector end-face across the solvent spot, then back and forth once across the dry area of the wipe or card.
- 4 Use a video probe to inspect the connector. If necessary, clean and inspect the connector again.

Note

For some connector types, such as VF-45, it is necessary to use a different method to clean the endface.

Chapter 3: How to Certify Fiber Cabling



Before you use the tester, read the safety information that starts on page 7.

Requirements for Reliable Fiber Test Results

To get reliable fiber test results and make sure your tester meets its accuracy specifications, you must use the correct procedures:

- Use proper cleaning procedures to clean all fiber connectors before every use. See Chapter 2.
- Set the reference frequently. See “About the Reference for Fiber Tests” on page 42.
- Use only test reference cords that comply with ISO/IEC 14763-3. Measure the loss of the cords frequently. See “About Test Reference Cords and Mandrels” on page 44.
- For multimode fiber, make sure you use the encircled flux test reference cords (EF-TRCs) or standard mandrels correctly. See “About the EF-TRC (Encircled-Flux Test Reference Cords)” on page 44 and “About Standard Mandrels” on page 47.
- Keep the tester’s software current. The latest software is available on the Fluke Networks website. See “Update the Software” on page 123.
- Make sure you select the correct fiber type and test limit for the job, and the index of refraction for the fiber is correct. See Table 2 on page 49.
- Make sure the battery is fully charged.

- Send the modules to a Fluke Networks service center every 12 months for factory calibration.

About the Reference for Fiber Tests

The reference procedure for fiber cable sets a baseline power level for loss measurements. If the power level that enters the fiber from the source changes, the reference and your loss measurements will be incorrect. The power level can change, for example, when the temperature at the job site increases or decreases or when you disconnect then reconnect a test reference cord at the tester's output port. So, it is important to set the reference frequently.

When to Set the Reference

Note

At the job site, turn on the testers and let them sit for a minimum of 5 minutes before you set the reference. Let them sit longer if they are above or below ambient temperature.

The tester requires you to set the reference at these times:

- When you change the CertiFiber Pro module in the main or remote tester.
- When you use a different remote tester.
- When you change the **Reference Method** in the test setup.

Set the reference also at these times:

- At the start of each day, at the job site, then at regular intervals during the day. For example, set the reference when you start tests on a different series of fibers.
- When you connect a test reference cord to the module's output port or to another source, even if you connect the same test reference cord you connected before.
- When the tester tells you that the reference is out of date.

- When a loss measurement is negative. This occurs when there was a problem when you set the reference. For example, an endface was dirty or the testers were cold.

 **Caution**

Do not disconnect the test reference cords from the modules' output ports after you set the reference. If you do, you will change the amount of optical power that enters the fiber and the reference will not be correct.

Good Reference Values

Reference values must be in these ranges:

- Multimode 50/125 μm fiber: -19.4 dBm to -26.5 dBm
- Multimode 62.5/125 μm fiber: -17.5 dBm to -23.0 dBm
- Singlemode fiber: -1.0 dBm to -6.0 dBm

If your reference value is outside of the applicable range given above, clean and inspect all connectors then set the reference again. Do this even if the tester lets you use the value.

If your test reference cords and connectors are in good condition, and you use the correct procedure to set the reference, the reference value will not change by more than approximately 0.4 dBm.

How to See the Reference Values

- After you set the reference, tap **View Reference** on the **SET REFERENCE** screen.
- After you do an Autotest, tap the result window for a fiber, then tap **VIEW REFERENCE**.

About Test Reference Cords and Mandrels

Use only test reference cords (TRCs) that have low loss:

- **Maximum loss for multimode TRCs:** ≤ 0.15 dB
- **Maximum loss for singlemode TRCs:** ≤ 0.25 dB

To make sure your test results are accurate as possible:

- Inspect the endfaces of the TRCs every 24 to 48 tests and clean them when necessary.
- Use the **TRC VERIFICATION** wizard available for the **1 Jumper** and **3 Jumper** reference methods to measure the losses of the TRCs. The losses of the TRCs are included in the loss measurements for links, so you must make sure the losses are very small. The wizard saves the results of the TRC tests to show that your TRCs were good. IDs for these results start with "TRC", show the date and time of the test, and have an  for the test result.

About the EF-TRC (Encircled-Flux Test Reference Cords)

The CFP-MM and CFP-QUAD kits includes the EF-TRC (encircled flux test reference cords), which have signal conditioners on the cords. When you use the EF-TRCs with the CertiFiber Pro multimode modules, your tester complies with IEC 61280-4-1, ISO/IEC 14763-3, and TIA-526-14-B standards for encircled flux. Measurements made with compliant equipment change less than 10 % for losses of 1 dB or more when you make them at different times or with different equipment that is also compliant.

Note

The IEC 61280-4-1, ISO/IEC 14763-3, and TIA-526-14-B standards require your optical loss test set to comply with encircled flux standards at 850 nm with 50 μm /125 μm fiber. The standards recommend compliance at 850 nm with 62.5 μm /125 μm fiber and at 1300 nm with 50 μm /125 μm and 62.5 μm /125 μm fiber.

 **Caution**

To prevent damage to fiber connectors, to prevent data loss, and to make sure that your test results are as accurate as possible:

- Use the EF-TRC cords only with the CertiFiber Pro modules or with sources approved by Fluke Networks for use with the cords. If a source does not have the correct LED and internal fibers, the EF-TRC cords will not make launch conditions that agree with encircled flux standards.
- When you use the EF-TRCs, DO NOT use other mandrels.
- Always follow the handling guidelines given in Figure 14.
- Put protective caps on all connectors when you do not use them.
- Use EF-TRCs that have the fiber core dimension (50 μm or 62. μm) and type of connectors (SC, ST, LC, or FC) that are the same as the fiber link. Do not use EF-TRCs with hybrid patch cords to connect to links that have other types of connectors.

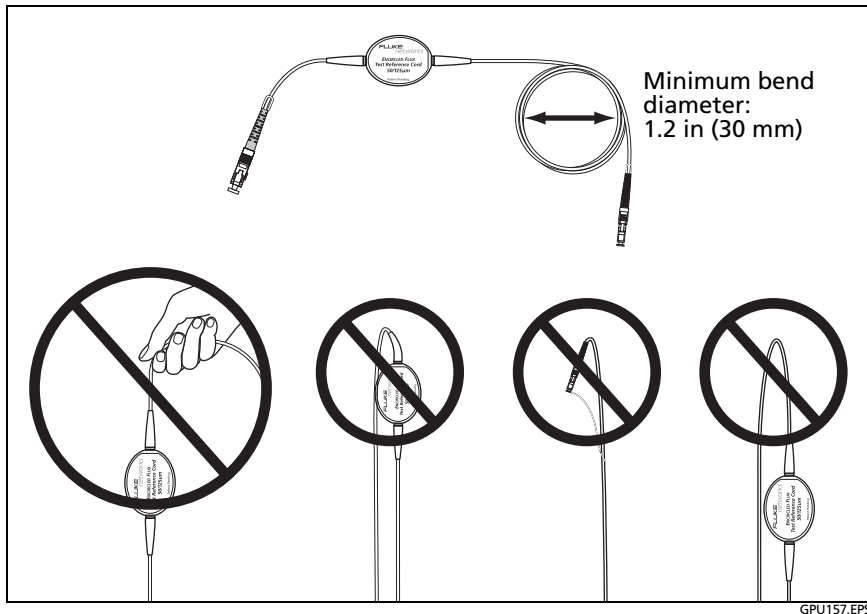

Figure 14. How to Prevent Damage to the EF-TRC Fiber Cables

About APC Connectors

When you do tests on links with APC (angled physical contact) connectors, use only test reference cords with APC connectors on the ends connected to the link. If you connect non-APC connectors to the link, the connectors will cause large reflections that make loss measurements inaccurate.

For tests on links with APC connectors, use test reference cords with APC connectors on the ends connected to the tester's input ports. This is necessary for the 1 jumper reference method. You can connect APC connectors to the tester's input ports because the fiber does not touch the lens on the input port.

Connect only UPC connectors to the tester's output ports.

About Standard Mandrels

Standard mandrels make measurements of multimode power loss more reliable than if you use no mandrels, but the measurements do not comply with the standards for encircled flux. Fluke Networks recommends that you always use only the EF-TRCs with the CertiFiber Pro multimode modules so that your measurements comply with EF standards.

If you must do tests in Far End Source mode with a different multimode source, and the source is not approved by Fluke Networks for use with the TRCs, use standard mandrels. Make sure you use the size of mandrel that is correct for 50 μm or 62.5 μm fiber, and read all instructions for the source and mandrel.

Caution

If you use mandrels for tests on multimode fiber, do not use test reference cords made from bend-insensitive fiber. The mandrels possibly will not remove all of the modes that can make your loss measurements unreliable.

Settings for Fiber Tests

Table 2 gives descriptions of the settings for fiber tests. To set up a project, which includes the settings in Table 2, cable IDs, and operator names, see Chapter 8.

To set up a fiber test

- 1 On the home screen, tap the test setup panel.
- 2 On the **CHANGE TEST** screen, select a fiber test to change, then tap **EDIT**.

Or to set up a new fiber test, tap **NEW TEST**. If no module is installed, the **MODULE** screen shows. Tap the correct CertiFiber Pro module.
- 3 On the **TEST SETUP** screen, tap the panels to change settings for the test. See Table 2.
- 4 On the **TEST SETUP** screen, tap **SAVE** when your test setup is completed.
- 5 On the **CHANGE TEST** screen, make sure the button next to the test is selected, then tap **USE SELECTED**.

Table 2. Settings for Fiber Tests

Setting	Description
Module	Select the CertiFiber Pro module you will use.
Test Type	<p>Use Smart Remote mode for tests on duplex-fiber cabling. See page 55.</p> <p>Use Loopback mode for tests on patch cords and cable spools. See page 64.</p> <p>Use Far End Source mode for tests on individual fibers. See page 72.</p>
Bi-Directional	<p>Off: The tester does fiber tests in only one direction.</p> <p>On: The tester does fiber tests in both directions. See “Bi-Directional Tests” on page 80.</p> <p>The Bi-Directional setting is not available for Far End Source mode.</p>
Fiber Type	Select a fiber type that is correct for the type you will test. To see a different group of fiber types, tap MORE , then tap a group. To make a custom fiber type, tap Custom in the Fiber Groups list. See the Technical Reference Handbook.
Fiber Type Settings	IOR: The tester uses the index of refraction to calculate the optical length of the fiber. Each fiber type includes the value specified by the manufacturer. To use a different IOR , make a custom fiber type. See the Technical Reference Handbook.
Test Limit	Select the correct test limit for the job. To see a different group of limits, tap MORE , then tap the name of a group. To make a custom limit, tap Custom in the Limit Groups list. See the Technical Reference Handbook.

-continued-

Table 2. Settings for Fiber Tests (continued)

<p>Reference Method</p>	<p>On the No. of Connectors/Splices screen, set the number of jumpers you will use in each fiber path when you set the reference. The dotted lines in the diagram on the screen show you which parts of the link are included in the test results.</p> <p>The number of jumpers you use has these effects on loss measurements:</p> <p>1 Jumper: Loss measurements include the connections at both ends of the link. The figures in this manual show 1 Jumper connections.</p> <p>2 Jumper: Loss measurements include one connection at one end of the link.</p> <p>3 Jumper: Loss measurements do not include the connections at the ends of the link. The tester measures only the loss of the fiber.</p> <p>This setting does not change the loss measurements, but it can change the PASS/FAIL result for test limits that use a calculated loss limit. For all test limits, the tester saves this setting to show the reference method you used.</p> <p style="text-align: center;"> Caution</p> <p style="text-align: center;">Most cable manufacturers will give you a warranty on a fiber installation only if you use the 1 Jumper reference method when you certify the installation.</p> <p style="text-align: center;"><i>Note</i></p> <p style="text-align: center;"><i>Different standards use different names for the three methods. See Appendix A.</i></p>
<p>Connector Type</p>	<p>Select the type of connector, such as SC or LC, used in the cabling. The tester saves this setting to record the type of connector you used. This setting does not change your test results or any of the diagrams that the tester shows. If the correct type is not in the list, select General.</p>

Table 2. Settings for Fiber Tests (continued)



<p>No. of Connectors/Splices</p>	<p>The Total Connections and Splices settings are applicable only if the selected test limit uses a calculated limit for loss.</p> <p>Total Connections: Enter the total number of connections that are in each path of the link. Do not adjust the number for the Reference Method you use. For example, if the link has 3 connections, enter “3” even if you use the 2 or 3 Jumper reference method. When the tester calculates the loss limit, it automatically removes the losses of the connections you used to set the reference.</p> <p style="text-align: center;"><i>Note</i></p> <p style="text-align: center;"><i>The CertiFiber Pro automatically adjusts the number of connections for the Reference Method you use. This is different from the DTX CableAnalyzer, where you do not include the reference connections in the number of connectors.</i></p> <p>Splices: Enter the number of splices in each path of the link.</p> <p>Jumper Reference: Enter the number of jumpers you will use in each fiber path when you set the reference. The dotted lines in the diagram on the screen show you which parts of the link are included in the test results. See Reference Method above.</p> <p>Figure 15 shows the No. of Connectors/Splices screen. Figure 16 shows how to count the jumpers, connectors, and splices for this setting.</p>
<p>TRC LENGTH (Test reference cord length)</p>	<p>You can enter length of your test reference cords when you set the reference. To enter this value, tap TRC LENGTH on the SET REFERENCE screen. The length you enter does not change the test results. The tester saves the length with the results to meet TIA reporting requirements.</p>

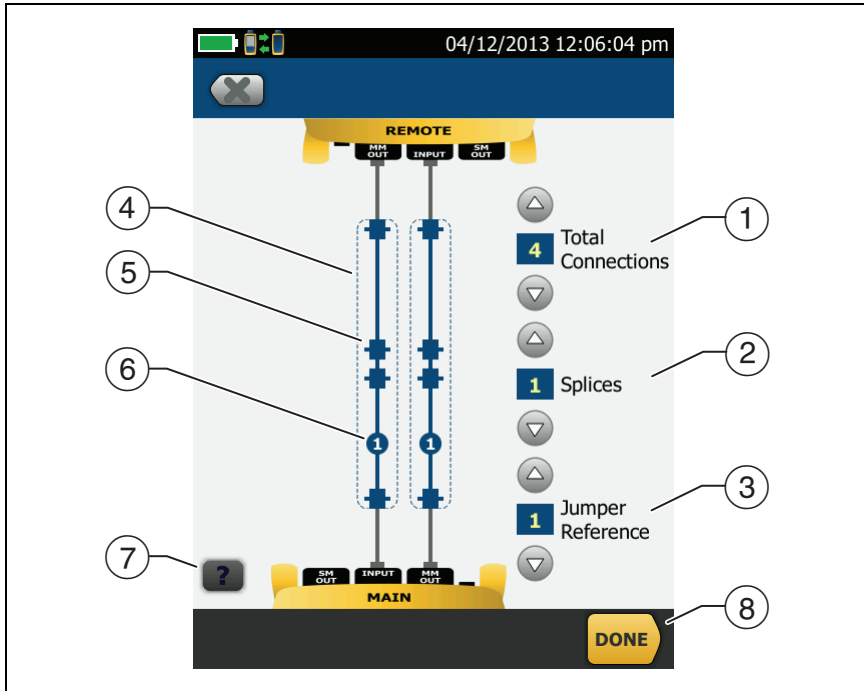

GPU140.EPS

Figure 15. Screen to Set the Number of Connectors, Splices, and Jumpers

- ① **Total Connections:** Enter the total number of connections that are in each path of the link. Do not adjust the number for the **Reference Method** you use. For example, if the link has 3 connections, enter "3" even if you use the 2 or 3 **Jumper** reference method. When the tester calculates the loss limit, it automatically removes the losses of the connections you used to set the reference.
- ② **Splices:** Enter the number of splices that are in each path of the link.

- ③ **Jumper Reference:** Enter the number of jumpers you will use in each fiber path when you set the reference. The dotted lines in the diagram on the screen show you which parts of the link are included in the test results. See **Reference Method** on page 50.
- ④ The dotted lines show you which parts of the link are included in the test results.
- ⑤ Connector icons show the connections between the ends of the link. If you enter 7 or more for the **Total Connections** setting, a number inside of a connector icon shows the number of connectors between the ends of the link. For example, if the **Total Connections** setting is 7, a connector icon shows the number 5 (.
- ⑥ The round icon shows the number of splices in each path of the link.
- ⑦ To see help for the screen, tap .
- ⑧ To save your settings, tap **DONE**.

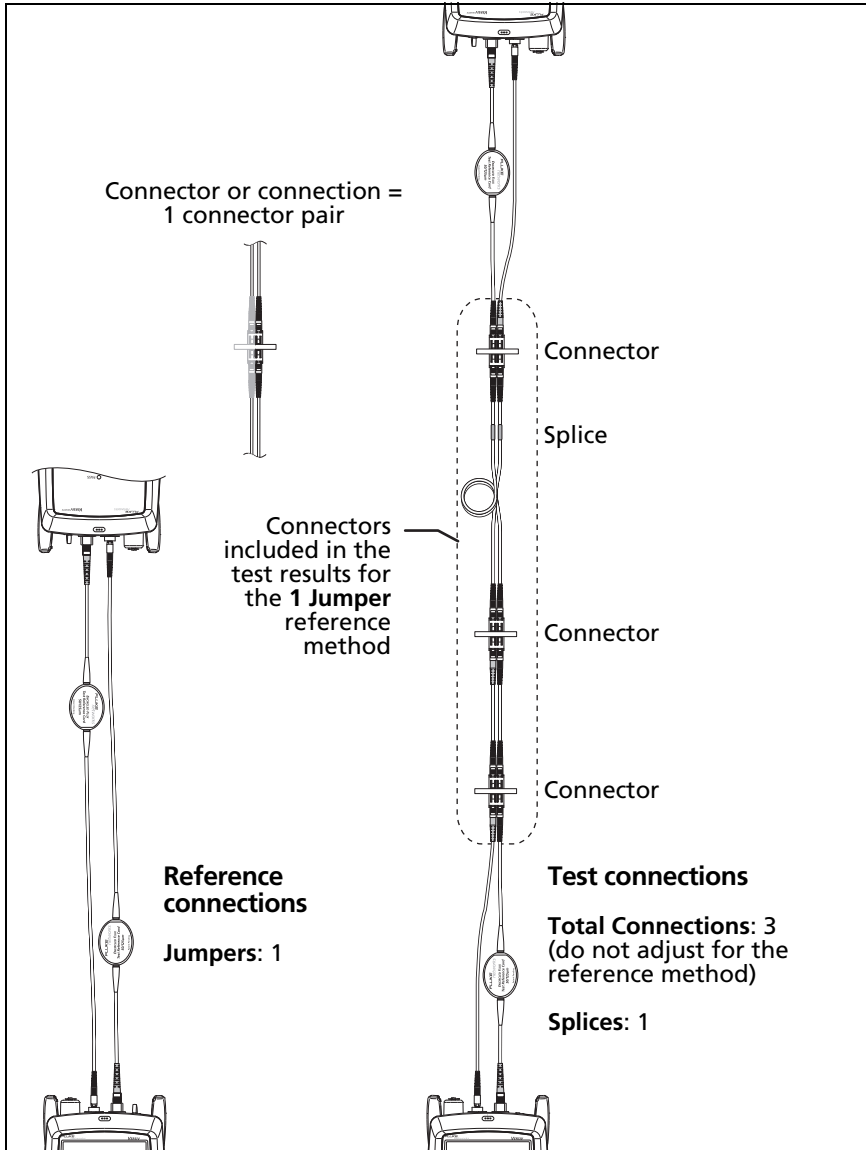

Figure 16. How to Count the Numbers of Connectors, Splices, and Jumpers

About 1 Jumper Reference Connections

The reference and test connections shown in this manual give 1 jumper results. 1 jumper results include the loss of the fiber plus the loss of the connections at both ends of the link. This is the best method for tests on premises fiber installations. Premises installations typically use patch cords at both ends of the link, and connector loss is a large part of the total loss.

If you do not have the correct connector adapters, see Appendix B for other connections that give 1 jumper results.

For descriptions of the 2 and 3 jumper reference connections, see the *Versiv Technical Reference Handbook*.

Caution

Most cable manufacturers will give you a warranty on a fiber installation only if you use a 1 Jumper reference when you certify the installation.

Note

If you use a 2 Jumper reference, the Wizard for the reference procedure does not show steps for the TRC verification. To save test results for the TRCs, do the tests manually.

Autotest in Smart Remote Mode

Use **Smart Remote** mode to do tests on dual-fiber cabling.

In this mode, the tester measures loss and length on two fibers at two wavelengths. If you turn on the **Bi-Directional** function, the tester makes measurements in both directions.

Figure 17 shows the equipment for tests in **Smart Remote** mode.

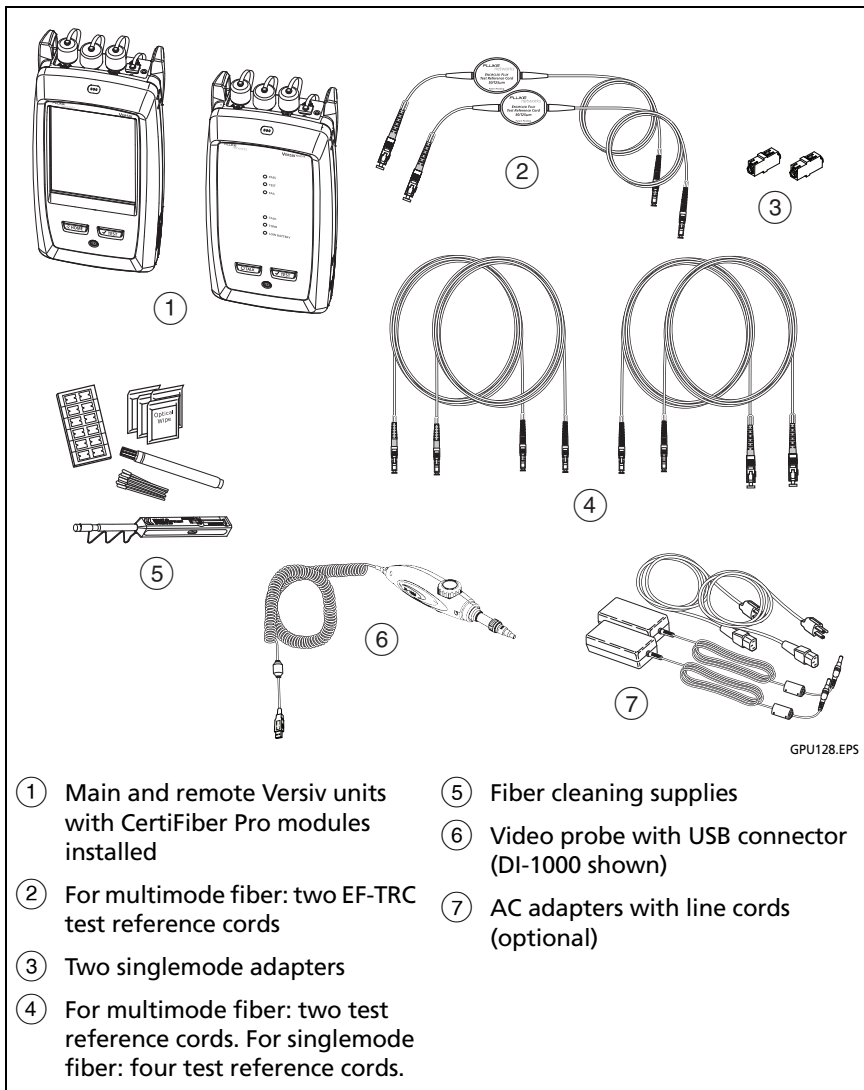

Figure 17. Equipment for Autotests in Smart Remote Mode

Step 1: Set the Reference in Smart Remote Mode

- 1-1 Turn on the tester and remote and let them sit for a minimum of 5 minutes. Let them sit longer if they are above or below ambient temperature.
- 1-2 Make sure that the home screen shows the correct settings for the job, and the test type is **Smart Remote**.

To make sure that other settings are correct, tap the test setup panel, make sure the correct test is selected on the **CHANGE TEST** screen, then tap **EDIT** to see more settings. Table 2 on page 49 describes the settings.

- 1-3 Clean and inspect the connectors on the tester, remote, and test reference cords.
- 1-4 On the home screen tap **SET REF**.
- 1-5 On the **SET REFERENCE** screen, tap **RUN WIZARD**.

Notes

*To only set the reference, and not measure the loss of your test reference cords, tap **SKIP WIZARD** on the **SET REFERENCE** screen.*

Fluke Networks recommends that you measure the loss of your test reference cords each time you set the reference.

- 1-6 Make the connections to set the reference, as shown on the screen and in Figure 18, then tap **NEXT** to see the completed connections.

Notes

*The **SET REFERENCE** screen shows reference connections for the selected reference method. Figure 18 shows connections for a **1 Jumper** reference.*

When you set the reference, align the testers as shown in Figure 18 to keep the fibers as straight as possible.

-continued-

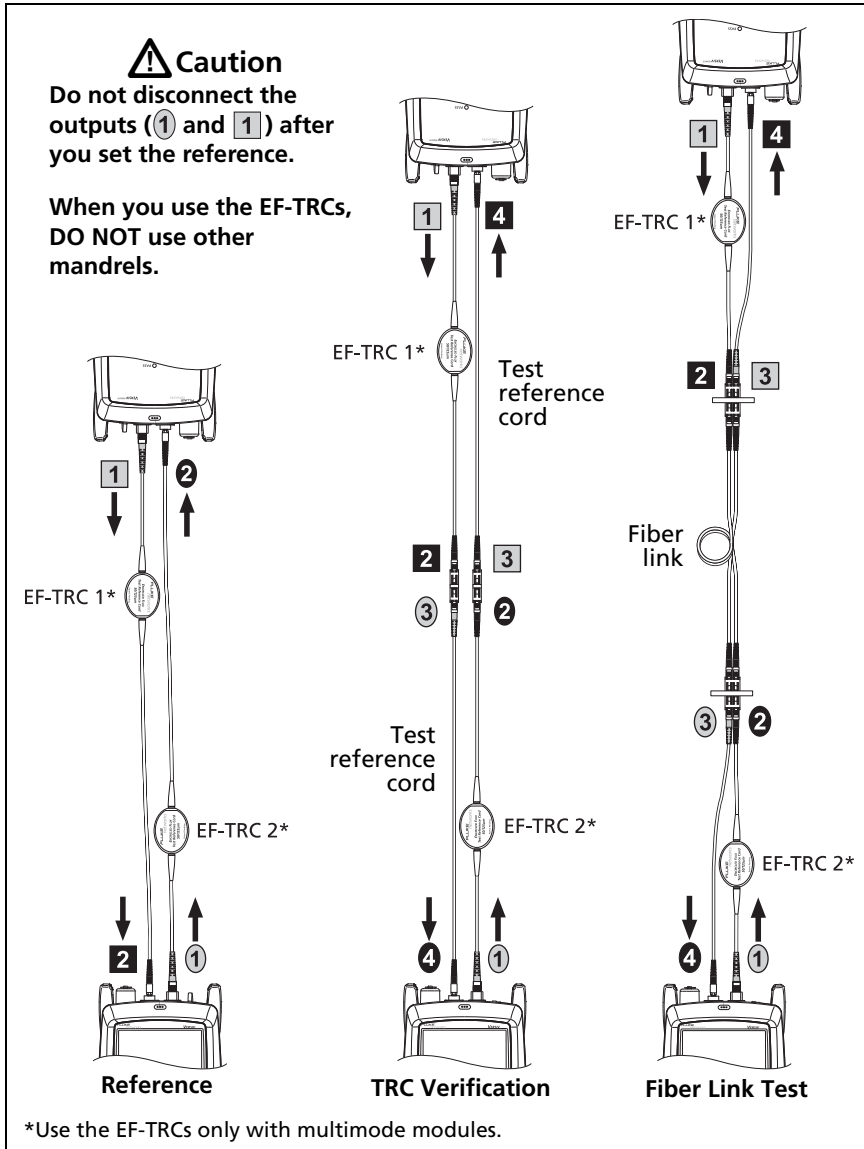

GPU122.EPS

**Figure 18. Connections for Smart Remote Mode
(1 Jumper Reference, Multimode Fiber)**

- 1-7 To enter the length of the test reference cords you will add to connect to the link, tap **TRC LENGTH** on the **SET REFERENCE** screen. The length you enter does not change the test results. The tester saves the length with the results to meet TIA reporting requirements.
- 1-8 Tap **SET REFERENCE**. If you did not use the connection wizard, go to step 3.

Step 2: Measure the Loss of the Test Reference Cords You Will Add

Caution

If you disconnected a test reference cord from the output of the tester or remote, you must set the reference again to make sure your measurements are reliable.

- 2-1 On the **SET REFERENCE** screen, when the reference procedure is completed, tap **NEXT**.
- 2-2 Disconnect the test reference cords from the **INPUT** ports on the tester and remote, then use test reference cords and adapters to make the connections to verify the TRCs, as shown on the screen and in Figure 18.
- 2-3 Tap **TRC VERIFICATION**. The tester measures and saves the loss of the test reference cords you added. The IDs for these results start with "TRC", show the date and time of the test, and have an  for the test result.

The tester shows a warning if the loss of a TRC is more than these limits:

- **Maximum loss for multimode TRCs:** 0.15 dB
- **Maximum loss for singlemode TRCs:** 0.25 dB

If the tester shows a warning, clean and inspect the connectors on the TRCs in the path that has too much loss, then set the reference and do the TRC verification again.

Step 3: Do an Autotest in Smart Remote Mode

Caution

If you disconnected a test reference cord from the output of the tester or remote, you must set the reference again to make sure your measurements are reliable.

- 3-1 On the **SET REFERENCE** screen, when the set reference or TRC verification procedure is completed, tap **NEXT** to see how to connect to the link under test.
- 3-2 Clean and inspect all the connectors.
- 3-3 Make the connections to do the test on the fiber link, as shown on the screen and in Figure 18, then tap **HOME**.
- 3-4 Tap **TEST** on the main tester or press  on the main or remote tester.

If the **CHECK FIBER CONNECTIONS** screen shows an open fiber:

- Make sure that all connections are good and no fibers have damage. Use the VFL to make sure the fibers in the link have continuity.
 - Make sure that the remote is on.
 - Switch the connections at one end of the patch panel.
 - If you are not sure you are connected to the correct fibers, connect the main tester's INPUT fiber to different connections until the test continues or the INPUT fiber on the display is green. Then if necessary, connect the remote's INPUT fiber to different connections until the test continues.
- 3-5 If **Bi-Directional** is **On**: Halfway through the test, the tester tells you to switch the input and output fibers. See "Bi-Directional Tests" on page 80.

3-6 Save the result:

- If **Auto Save** is on, the tester uses the next two IDs to save the results for the two fibers.
- If **Auto Save** is off, tap **SAVE** if the test passed or **FIX LATER** if the test failed. The **SAVE RESULT** screen shows the next two IDs available. You can change the IDs if necessary.

Autotest Results for Smart Remote Mode

Unsaved results show the results for both fibers. See Figure 19.

Fiber IDs for Saved Results in Smart Remote Mode

If **Auto Save** is **On** and the test passed, the tester saves two records, one for each fiber. The records have the next two IDs in the ID list.

If you must change the ID for a fiber before you save results, set **Auto Save** to **Off** before you do the test. Then, on the **SAVE RESULT** screen, tap the **Input Fiber ID** or **Output Fiber ID** window.

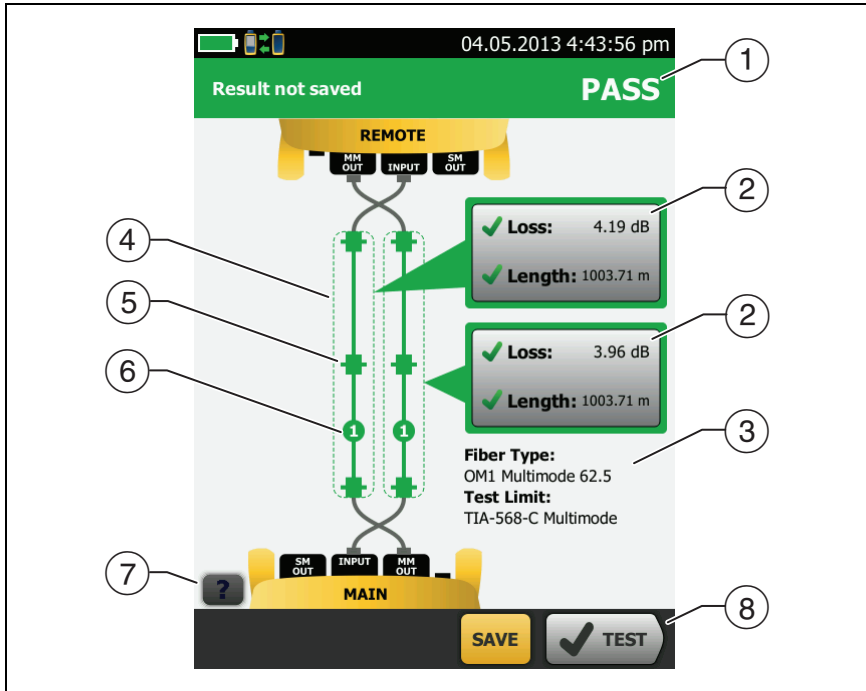

GPU118.EPS

Figure 19. Result for Smart Remote Mode (Unsaved Bi-Directional Results Shown)

- ① The overall result for the Autotest.
- ② The fiber IDs and the loss and length measurements for the fibers:
 - ✘ The result exceeds the limit.
 - ✔ The result is within the limit.
 - ℹ The selected test limit does not have a limit for the test.

To see the results, limits, and margins for a fiber, tap the window.

- ③ The settings the tester used for the test.
- ④ The dashed lines are around the connectors and fiber that are included in the loss and length results. Gray connectors and fibers are not included because you used them to set the reference.
- ⑤ Connector icons show the number you entered for the **TOTAL CONNECTIONS** setting on the **No. of Connectors/Splices** screen (Figure 15 on page 52). For Figure 19, the **TOTAL CONNECTIONS** setting is 4.
- ⑥ The round icon shows the number of splices entered for the **SPLICES** setting on the **No. of Connectors/Splices** screen.
- ⑦ To see help for the screen, tap .
- ⑧ When more than one button shows at the bottom of the screen, the tester highlights one in yellow to recommend which one to tap. See “Buttons to Do Tests and Save Results” on page 23.

Autotest in Loopback Mode

Use **Loopback** mode to do tests on spools of cable and segments of uninstalled cable.

In this mode, the tester measures loss and length at two wavelengths. If you turn on the **Bi-Directional** function, the tester makes measurements in both directions.

Figure 17 shows the equipment for tests in Loopback Mode.

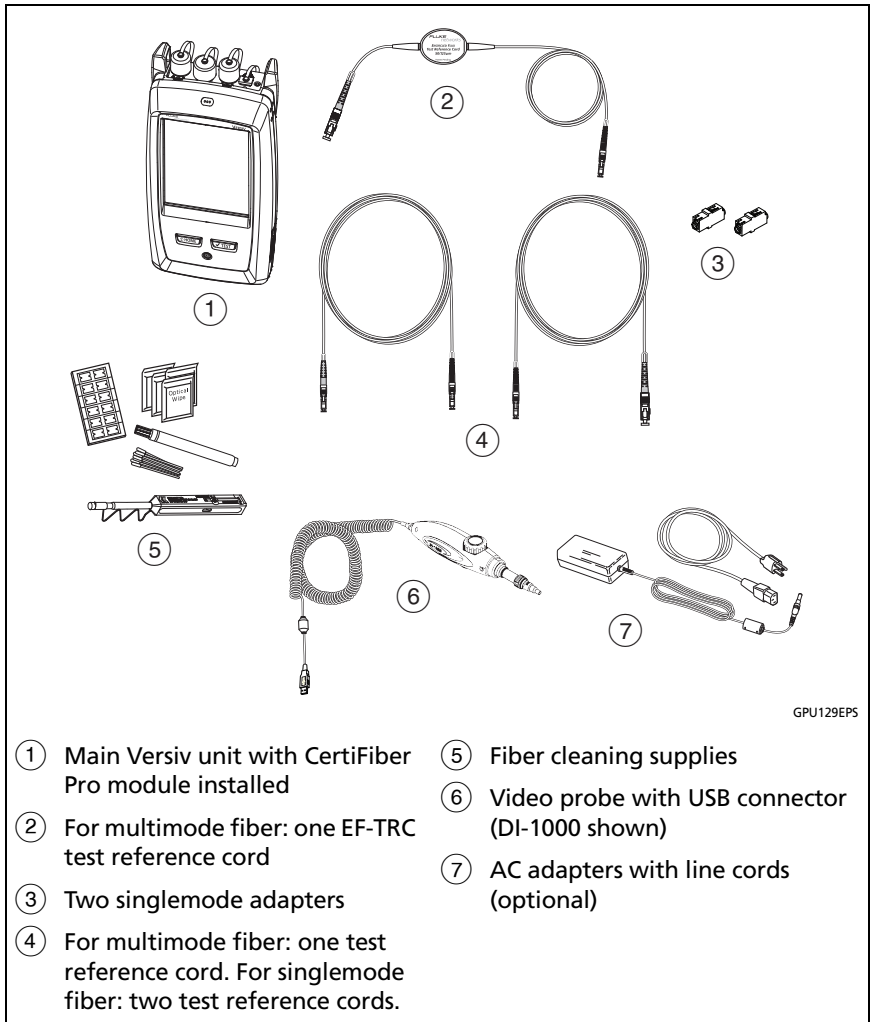

Figure 20. Equipment for Autotests in Loopback Mode

Step 1: Set the Reference in Loopback Mode

- 1-1 Turn on the tester and let it sit for a minimum of 5 minutes. Let it sit longer if it is above or below ambient temperature.
- 1-2 Make sure that the home screen shows the correct settings for the job, and the test type is **Loopback**.

To make sure that other settings are correct, tap the test setup panel, make sure the correct test is selected on the **CHANGE TEST** screen, then tap **EDIT** to see more settings. Table 2 on page 49 describes the settings.
- 1-3 Clean and inspect the connectors on the tester and test reference cords.
- 1-4 On the home screen tap **SET REF**.
- 1-5 On the **SET REFERENCE** screen, tap **RUN WIZARD**.

Notes

*To only set the reference, and not measure the loss of your test reference cord, tap **SKIP WIZARD** on the **SET REFERENCE** screen.*

Fluke Networks recommends that you measure the loss of your test reference cord each time you set the reference.

- 1-6 Make the connection to set the reference, as shown on the screen, then tap **NEXT** to see the completed connections. Figure 21 also shows the completed connections.

Notes

*The **SET REFERENCE** screen shows reference connections for the selected reference method. Figure 21 shows connections for the **1 Jumper** reference.*

When you set the reference, keep the fiber as straight as possible.

-continued-

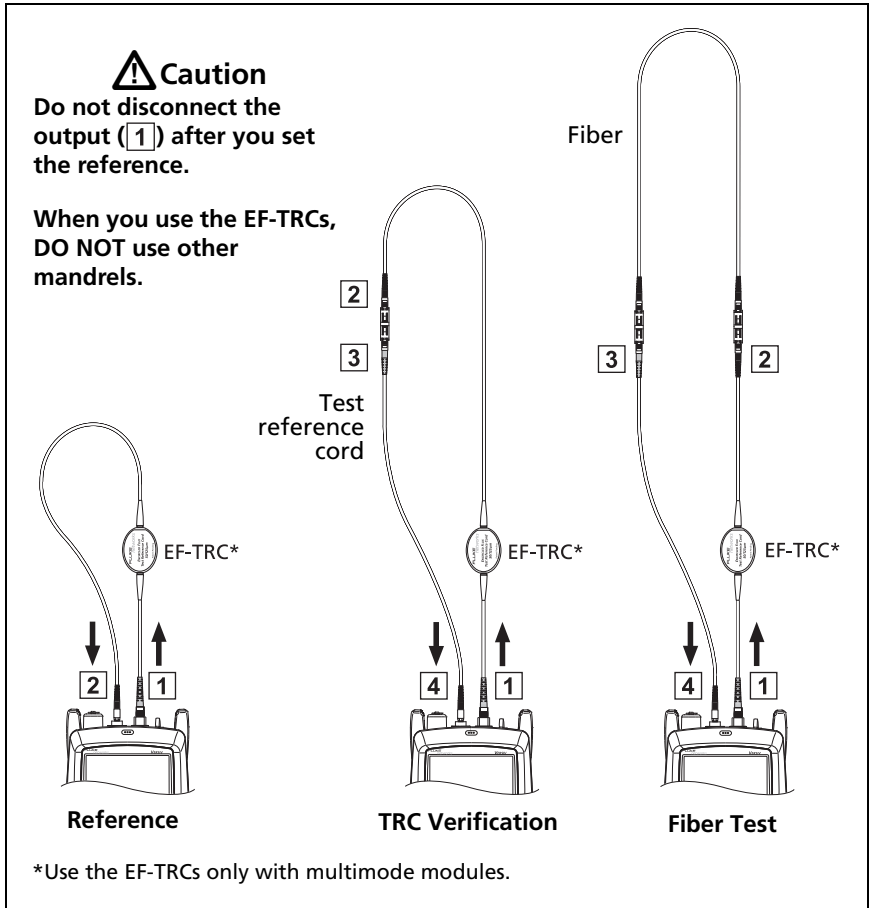

GPU131.EPS

Figure 21. Connections for Loopback Mode
(1 Jumper Reference, Multimode Fiber)

- 1-7 To enter the length of the test reference cord you will add to connect to the fiber under test, tap **TRC LENGTH** on the **SET REFERENCE** screen. The length you enter does not change the test results. The tester saves the length with the results to meet TIA reporting requirements.
- 1-8 Tap **SET REFERENCE**.
- 1-9 If you did not use the connection wizard, go to step 3.

Step 2: Measure the Loss of the Test Reference Cord You Will Add

Caution

If you disconnected the test reference cord from the output of the tester, you must set the reference again to make sure your measurements are reliable.

- 2-1 On the **SET REFERENCE** screen, when the reference procedure is completed, tap **NEXT**.
- 2-2 Disconnect the test reference cord from the INPUT port on the tester, then use a test reference cord and adapter to make the connections to verify the TRCs, as shown on the screen and in Figure 21.
- 2-3 Tap **TRC VERIFICATION**. The tester measures and saves the loss of the test reference cord you added. The ID for this result starts with "TRC", shows the date and time of the test, and has an  for the test result.

The tester shows a warning if the loss of a TRC is more than these limits:

- **Maximum loss for multimode TRCs: 0.15 dB**
- **Maximum loss for singlemode TRCs: 0.25 dB**

If the tester shows a warning, clean and inspect the connectors on the TRC, then set the reference and do the TRC verification again.

Step 3: Do an Autotest in Loopback Mode

Caution

If you disconnected the test reference cord from the output of the tester, you must set the reference again to make sure your measurements are reliable.

- 3-1 On the **SET REFERENCE** screen, when the set reference or TRC verification procedure is completed, tap **NEXT** to see how to connect to the fiber under test.
- 3-2 Clean and inspect the connectors on the fiber under test.
- 3-3 Make the connections to do the test on the fiber, as shown on the screen and in Figure 21, then tap **HOME**.
- 3-4 Tap **TEST** on the main tester or press  on the main or remote tester.

If the **CHECK FIBER CONNECTIONS** screen shows an open fiber:

- Make sure that all connections are good and no fibers have damage. Use the VFL to make sure the fiber under test has continuity.
 - If you are connected to fibers at a patch panel that are connected together at the far end, and you are not sure you are connected to the correct fibers, connect the main tester's INPUT fiber to different connections until the test continues.
- 3-5 If **Bi-Directional** is **On**: Halfway through the test, the tester tells you to switch the input and output fibers. See "Bi-Directional Tests" on page 80.
 - 3-6 If **Auto Save** is on, the tester uses the next ID to save the results.

If **Auto Save** is off, the **SAVE RESULT** screen shows the next ID available. You can change the ID if necessary.

Autotest Results for Loopback Mode

Figure 22 shows an example of Autotest results for Loopback mode.

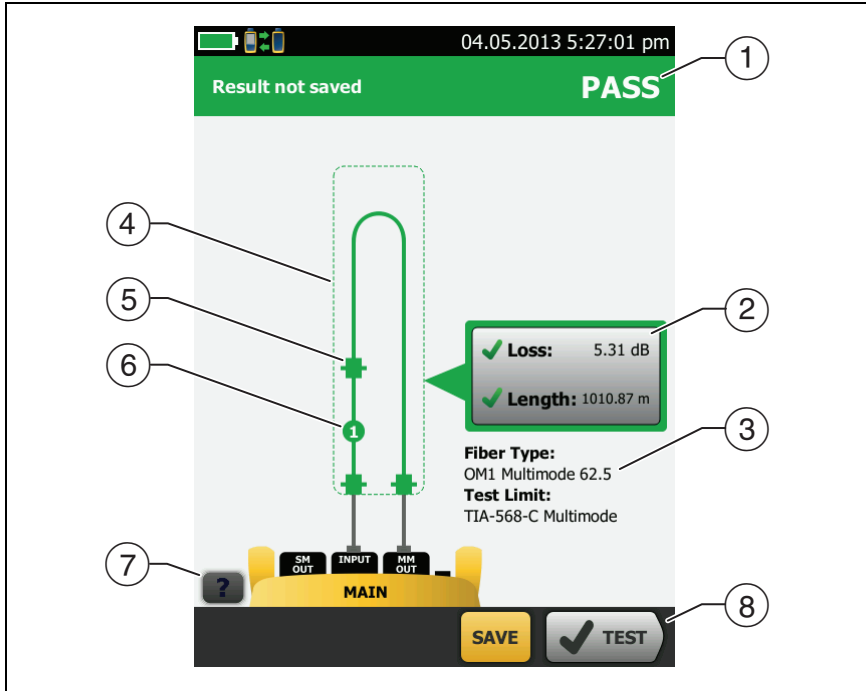

GPU119.EPS

Figure 22. Result for Loopback Mode

- ① The overall result for the Autotest.
- ② The loss and length measurements for the fiber:
 - ✗ The result exceeds the limit.
 - ✓ The result is within the limit.
 - ℹ The selected test limit does not have a limit for the test.

To see the results, limits, and margins for the fiber, tap the window.

- ③ The settings the tester used for the test.
- ④ The dashed lines are around the connectors and fiber that are included in the loss and length results. Gray connectors and fibers are not included because you used them to set the reference.
- ⑤ Connector icons show the number you entered for the **TOTAL CONNECTIONS** setting on the **No. of Connectors/Splices** screen (Figure 15 on page 52). For Figure 22, the **TOTAL CONNECTIONS** setting is 3.
- ⑥ The round icon shows the number of splices entered for the **SPLICES** setting on the **No. of Connectors/Splices** screen.
- ⑦ To see help for the screen, tap .
- ⑧ When more than one button shows at the bottom of the screen, the tester highlights one in yellow to recommend which one to tap. See “Buttons to Do Tests and Save Results” on page 23.

Autotest in Far End Source Mode

Use **Far End Source** mode to measure loss at two wavelengths on one fiber.

In this mode, you can use the CertiFiber Pro remote or another source, such as the Fluke Networks SimpliFiber® Pro source, at the far end of the fiber.

Caution

For Far End Source mode, use the EF-TRC cords only with the CertiFiber Pro modules or with sources approved by Fluke Networks for use with the cords. If a source does not have the correct LED and internal fibers, the EF-TRC cords will not make launch conditions that comply with encircled flux standards. If the source is not approved, use a standard mandrel.

Figure 23 shows the equipment for tests in Far End Source mode.

Auto Wavelength Modes

CertiFiber Pro modules and SimpliFiber Pro sources have an auto wavelength mode. In this mode, the output port transmits both wavelengths (850 nm and 1300 nm or 1310 nm and 1550 nm). The signal includes identifiers that tell the meter when to measure power at each wavelength. The CertiFiber Pro module in the remote always operates in auto wavelength mode.

To select **Auto CertiFiber Pro** or **Auto SimpliFiber Pro** mode, you tap the setting when the tester shows the **TEST MODE** window. The **TEST MODE** window shows each time you set the reference.

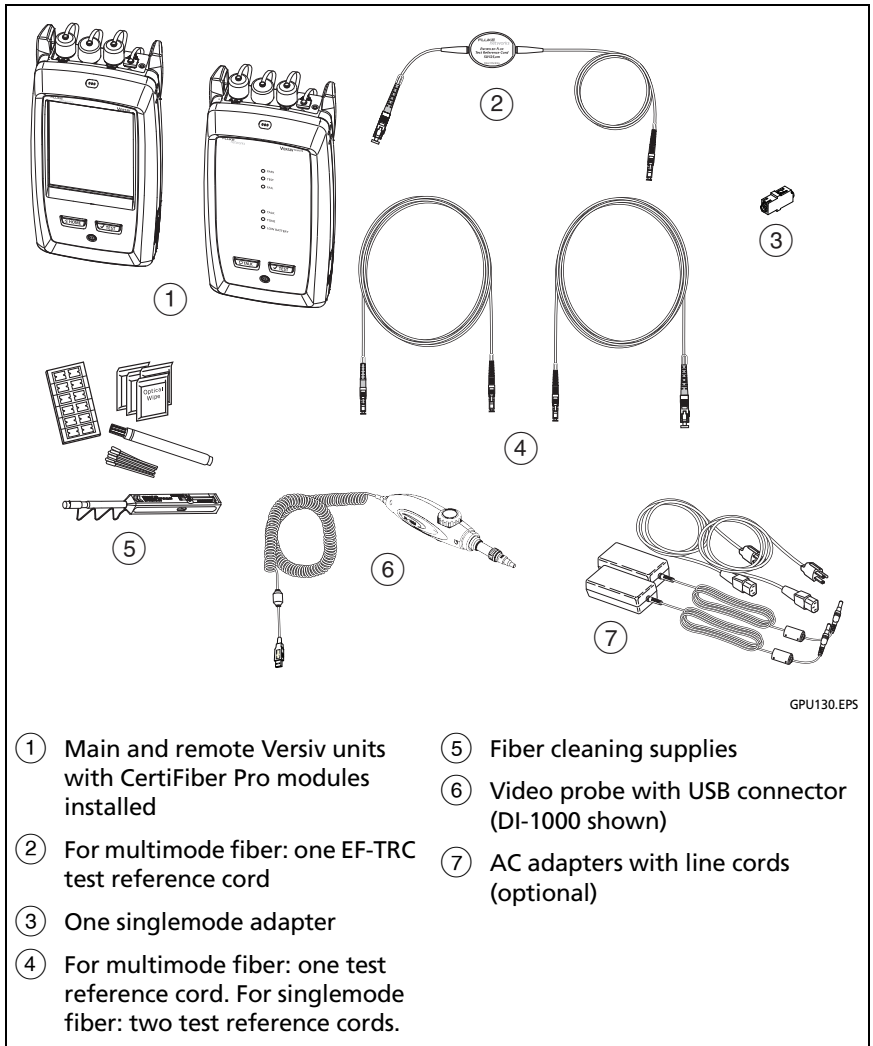

Figure 23. Equipment for Autotests in Far End Source Mode

Step 1: Set the Reference in Far End Source Mode

- 1-1 Turn on the tester and source let them sit for a minimum of 5 minutes. Let them sit longer if they are above or below ambient temperature, or if the instructions for the source specify a longer time.
- 1-2 Make sure that the home screen shows the correct settings for the job, and the test type is **Far End Source**.

To make sure that other settings are correct, tap the test setup panel, make sure the correct test is selected on the **CHANGE TEST** screen, then tap **EDIT** to see more settings. Table 2 on page 49 describes the settings.
- 1-3 Clean and inspect the connectors on the tester, source, and test reference cords.
- 1-4 On the home screen tap **SET REF**.
- 1-5 In the **TEST MODE** window, select **Auto CertiFiber Pro** or the type of source you will use, then tap **DONE**.
- 1-6 On the **SET REFERENCE** screen, tap **RUN WIZARD**.

Notes

*To only set the reference, and not measure the loss of your test reference cord, tap **SKIP WIZARD** on the **SET REFERENCE** screen.*

Fluke Networks recommends that you measure the loss of your test reference cord each time you set the reference.

- 1-7 Make the connections to set the reference as shown on the screen, then tap **NEXT** to see the completed connections. Figure 24 also shows the completed connections.

Notes

*The **SET REFERENCE** screen shows reference connections for the selected reference method. Figure 24 shows connections for the **1 Jumper** reference.*

When you set the reference, keep the fiber as straight as possible.

- 1-8** Turn on the optical source. On the CertiFiber Pro remote module, hold down the button adjacent to the VFL port for 3 seconds to turn on the multimode source.

On CFP-QUAD modules, to turn on the singlemode source, press the button again.

Note

The CertiFiber Pro module in the remote always operates in auto wavelength mode. The output port transmits both wavelengths (850 nm and 1300 nm or 1310 nm and 1550 nm). The signal includes identifiers that tell the main tester when to measure power at each wavelength.

- 1-9** To enter the length of the test reference cord you will add to connect to the fiber under test, tap **TRC LENGTH** on the **SET REFERENCE** screen. The length you enter does not change the test results. The tester saves the length with the results to meet TIA reporting requirements.
- 1-10** Tap **SET REFERENCE**.
- 1-11** If you did not use the connection wizard, go to step 3.

⚠ Caution

Do not disconnect the output (1) after you set the reference.

When you use the EF-TRCs, DO NOT use other mandrels.

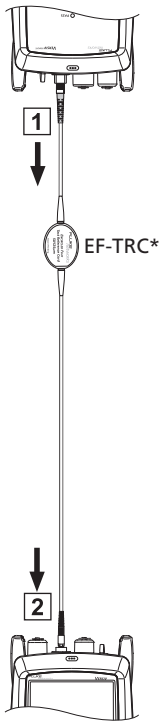

Reference

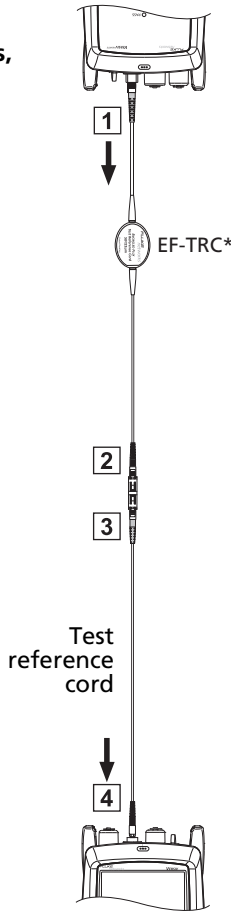

TRC Verification

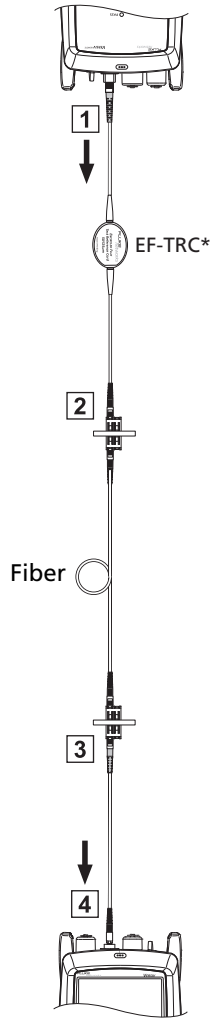

Fiber Test

*Use the EF-TRCs only with multimode modules.

GPU132.EPS

**Figure 24. Connections for Far End Source Mode
(1 Jumper Reference Multimode Fiber)**

Step 2: Measure the Loss of the Test Reference Cord You Will Add

Caution

If you disconnected the test reference cord from the output of the tester, you must set the reference again to make sure your measurements are reliable.

- 2-1 On the **SET REFERENCE** screen, when the reference procedure is completed, tap **NEXT**.
- 2-2 Disconnect the test reference cord from the **INPUT** port on the tester, then use a test reference cord and adapter to make the connections to verify the TRCs, as shown on the screen and in Figure 24.
- 2-3 Tap **TRC VERIFICATION**. The tester measures and saves the loss of the test reference cord you added. The ID for this result starts with "TRC", shows the date and time of the test, and has an  for the test result.

The tester shows a warning if the loss of a TRC is more than these limits:

- **Maximum loss for multimode TRCs:** 0.15 dB
- **Maximum loss for singlemode TRCs:** 0.25 dB

If the tester shows a warning, clean and inspect the connectors on the TRC, then set the reference and do the TRC verification again.

Step 3: Do an Autotest in Far End Source Mode

Caution

If you disconnected the test reference cord from the output of the tester, you must set the reference again to make sure your measurements are reliable.

- 3-1 On the **SET REFERENCE**, when the set reference or TRC verification procedure is completed, tap **NEXT** to see how to connect to the fiber under test.
- 3-2 Clean and inspect the all connectors.
- 3-3 Make the connections to do the test on the fiber, as shown on the screen and in Figure 24, then tap **HOME**.
- 3-4 Tap **TEST** on the main tester or press TEST on the main or remote tester.
- 3-5 If the **CHECK FIBER CONNECTIONS** screen shows an open fiber:
 - Make sure that all connections are good and no fibers have damage. Use the VFL to make sure the fiber under test has continuity.
 - If you are connected to a fiber at a patch panel, and you are not sure you are connected to the correct fiber, connect the main tester's INPUT fiber to different connections until the test continues.
- 3-6 If **Auto Save** is on, the tester uses the next ID to save the results.

If **Auto Save** is off, the **SAVE RESULT** screen shows the next ID available. You can change the ID if necessary.

Autotest Results for Far End Source Mode

Figure 25 shows an example of Autotest results for Far End Source mode.

Note

The Autotest in Far End Source mode does not show a PASS/FAIL result, limit, or margin if the selected test limit uses fiber length to calculate loss. An example of such a limit is the TIA-568C Fiber Backbone limit. The tester does not measure length in Far End Source mode.

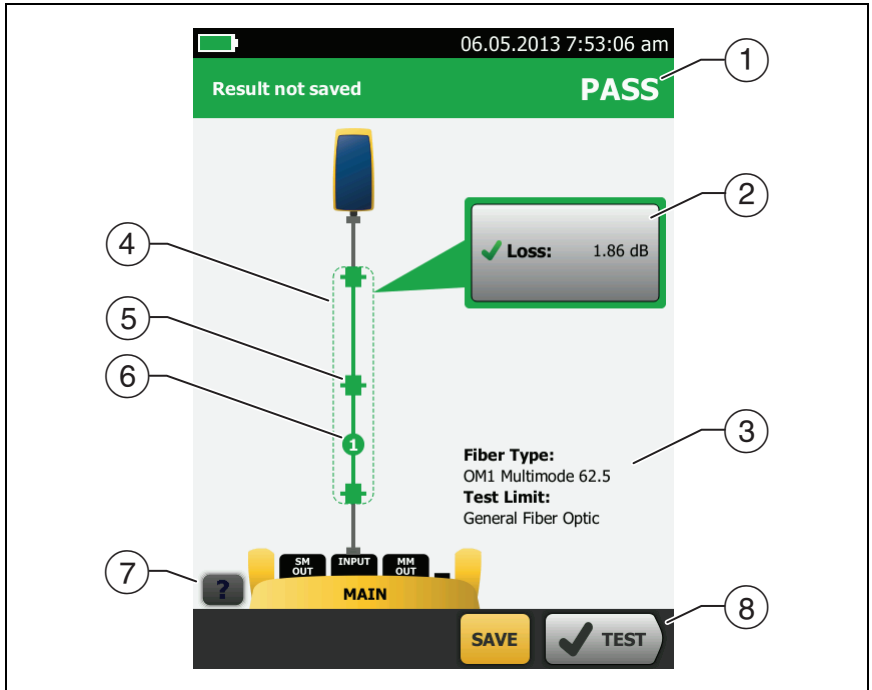

GPU120.EPS

Figure 25. Result for Far End Source Mode

- ① The overall result for the Autotest.
- ② The loss and length measurements for the fiber:
 - ✖ The result exceeds the limit.
 - ✔ The result is within the limit.
 - ℹ The selected test limit does not have a limit for the test.To see the results, limit, and margins for the fiber, tap the window.
- ③ The settings the tester used for the test.

- ④ The dashed lines are around the connectors and fiber that are included in the loss and length results. Gray connectors and fibers are not included because you used them to set the reference.
- ⑤ Connector icons show the number you entered for the **TOTAL CONNECTIONS** setting on the **No. of Connectors/Splices** screen (Figure 15 on page 52). For Figure 25, the **TOTAL CONNECTIONS** setting is 1.
- ⑥ The round icon shows the number of splices entered for the **SPLICES** setting on the **No. of Connectors/Splices** screen.
- ⑦ To see help for the screen, tap .
- ⑧ When more than one button shows at the bottom of the screen, the tester highlights one in yellow to recommend which one to tap. See “Buttons to Do Tests and Save Results” on page 23.

Bi-Directional Tests

A connector or splice can have a different loss when you measure from the other end of the fiber. Thus, some manufacturers of fiber cable and components will not give you warranty support unless you do bi-directional tests. Do bi-directional tests when they are required by the manufacturer or by your customer.

The tester can automatically do bi-directional tests in Smart Remote and Loopback modes. To get bi-directional results in Far End Source mode, do a test from each end of the fiber.

In Smart Remote mode, the tester saves bi-directional results in two records. Each record contains the results for one fiber for both directions.

To do a bi-directional test

- 1 On the home screen, tap the test setup panel, make sure the correct test is selected on the **CHANGE TEST** screen, then tap **EDIT**.
- 2 On the **TEST SETUP** screen, in the **Bi-Directional** panel, tap the control to make it show **On**, then tap **SAVE**.

- 3 Do an Autotest.
- 4 Halfway through the test, the tester tells you to switch the input and output fibers.

 **Caution**

Switch the connections at both ends of the patch panel or fiber under test, not at the tester's and remote's ports. If you disconnect a test reference cord from an output port on the tester or remote, the reference value will be unreliable.

Note

*The directions **Main>Remote** (main to remote) and **Remote>Main** (remote to main) in the bi-directional results are only the directions of the optical signals for the second half of the test. If a fiber fails, the direction does not tell you the location of the problem.*

- 5 If **Auto Save** is on and the tester is in Smart Remote mode, the tester uses the next two IDs to save the results for the two fibers.

If **Auto Save** is off, the **SAVE RESULT** screen shows the next two IDs available. You can change the IDs if necessary.

Chapter 4: The FiberInspector Test

The optional DI-1000 video probe connects to the type A USB port on the Versiv main unit to let you inspect the endfaces in fiber optic connectors. The probe lets you see dirt, scratches, and other defects that can cause unsatisfactory performance or failures in fiber optic networks.

How to Do the FiberInspector Test

Figure 26 shows the equipment for a FiberInspector test.

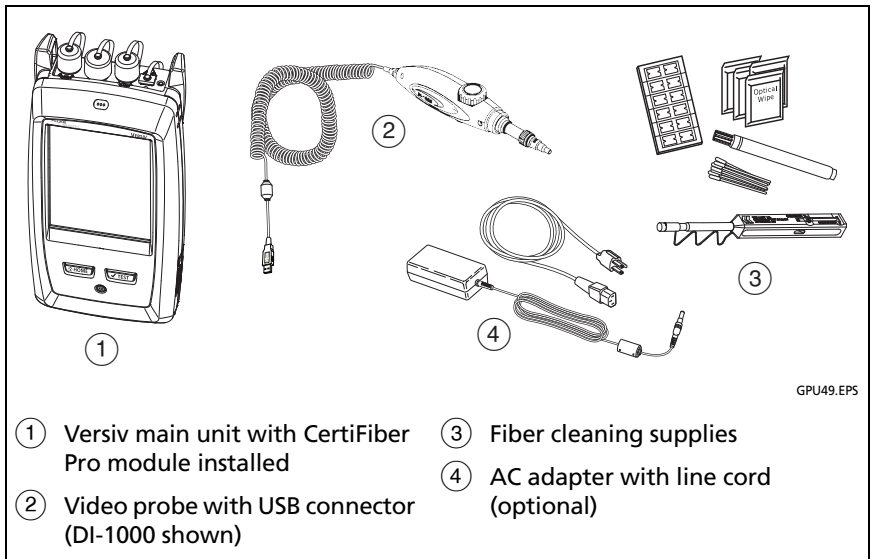

Figure 26. Equipment for the FiberInspector Test

To do the FiberInspector test

- 1 Connect the probe to the type A USB port on the side of the tester.
- 2 Make sure the correct tip is on the probe.
- 3 Clean the connector that you will inspect.
- 4 Do the FiberInspector test:

To do the FiberInspector test when it is in the project

- a. On the home screen, tap the test setup panel.
- b. On the **CHANGE TEST** screen, tap the **FiberInspector** test, then tap **USE SELECTED**.
- c. Tap **Test** or press **TEST**.

To do the FiberInspector test when it is not in a project



On the home screen, tap the **TOOLS** icon, then tap **FiberInspector**.

- 5 Insert the probe into the connector.
- 6 To adjust the focus, turn the knob on the probe clockwise or counterclockwise.

Note

The button on the DI-1000 probe has no function when you use the probe with the Versiv unit.

- 7 To save the image, tap **SAVE**.
- 8 On the **SAVE RESULT** screen, select **End 1** or **End 2**, make sure the **Cable ID** and **End** name are correct, then tap **SAVE**.

Saved FiberInspector results show these icons for **End 1** and **End 2**:  

Notes

*The **Auto Save** function does not operate with the FiberInspector test.*

Continuous use of the video probe decreases the battery life. To increase the battery life, connect the ac adapter when you use the probe for more than a few minutes.

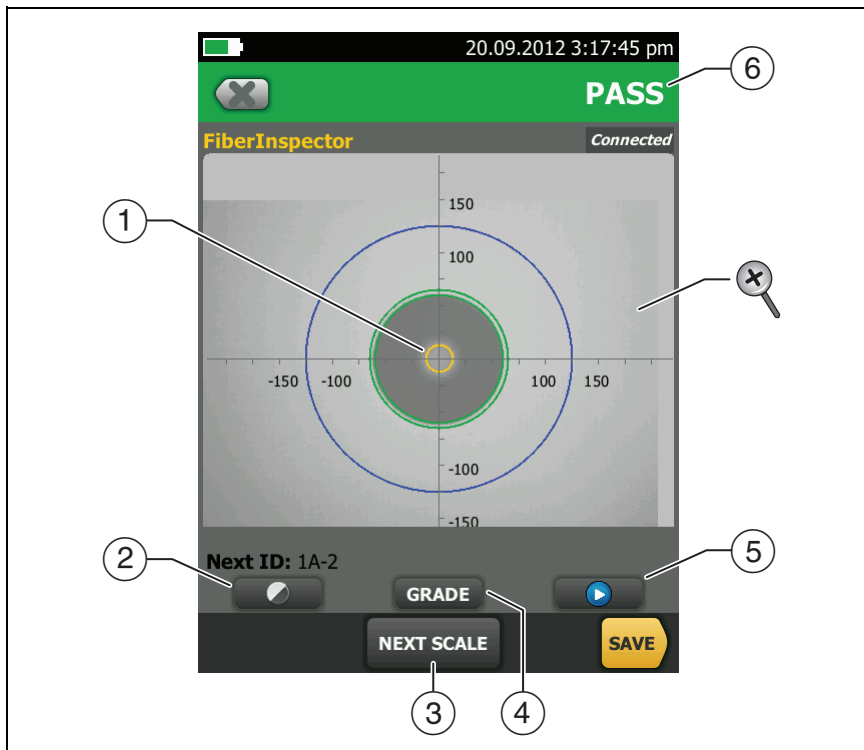

GPU25.EPS

**Figure 27. FiberInspector Image with Measurement Scales
(fiber with 50 μm core shown)**







Note

To see the buttons for the measurement axes and core scales and to change the magnification of the screen, you must first tap  to put the screen in still mode.

- ① You can use the round, horizontal, and vertical scales to measure the size of the fiber core and cladding. You can also measure the size of particles, scratches, and other defects on the endface.

To show the scales, tap **SCALE ON** (③).

- Outer, blue ring: 250 μm cladding
- Middle, green rings: 120 μm and 130 μm
- Inner, yellow rings: 25 μm and 62.5 μm (to change the size, tap **NEXT SCALE**)

- ② To adjust the brightness or contrast of the image, tap , then move the bars on the controls. To hide the controls, tap  again.
 - ③ To show the scales (①), tap , then tap **SCALE ON**. To change the size of the measurement ring for the fiber core, tap **NEXT SCALE**.
 - ④ To give a **PASS** or **FAIL** grade to the image, tap **GRADE**. See ⑥.
 - ⑤ To put the screen in still mode and turn off the probe, tap . Tap  to turn on the probe again.
 - ⑥ To give the image a grade of **PASS** or **FAIL**, tap **GRADE** (④). If you set the grade to **FAIL**, then save the image, the ID for the image is in the list of tests to do again.
-  To zoom in and out, tap  to put the screen in still mode, then use the pinch, reverse-pinch, and double-tap gestures on the touchscreen. See Figure 6 on page 22.

Chapter 5: The Visual Fault Locator

Visual Fault Locator Applications

The CertiFiber Pro modules include a visual fault locator that sends a red light down the fiber. The red light shows at the end of the fiber and at breaks, cracks, and sharp bends along the fiber.

The VFL also helps you quickly verify the continuity of fibers, identify connectors, and find faults along fibers and in connectors.

The VFL helps you do these tasks:

- Quickly verify the continuity of fibers.
- Identify the polarity of duplex connections.
- Identify connections in patch panels.
- See breaks and bad splices. These faults cause the fiber to emit red light.
- See high-loss bends. If you can see the light from the VFL at a bend in a fiber, the bend is too sharp.
- See connectors that have damaged fibers inside. A damaged fiber inside a connector causes a red light in the connector.
- Increase the quality of mechanical splices and pre-polished connectors: Before you seal the splice or connector, adjust the fiber alignment for the minimum amount of light where the fibers touch. (Refer to the instructions from the manufacturer when you make splices and connectors.)

How to Use the VFL

Figure 28 shows the equipment for tests with the visual fault locator.

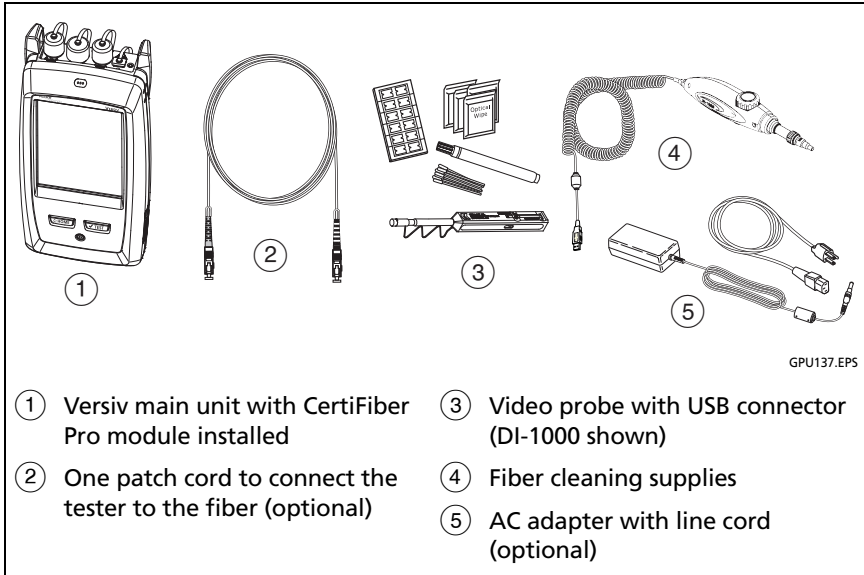

Figure 28. Equipment for Visual Fault Locator Tests

To use the visual fault locator

Note

You can connect the visual fault locator to connectors that have 2.5 mm ferrules (SC, ST, or FC). To connect to other ferrule sizes, use a test reference cord with the correct connector at one end and a SC, ST, or FC connector at the tester end.

- 1 Clean and inspect the connectors on the patch cord, if used, and the fiber to be tested.
- 2 Connect the fiber directly to the VFL port or use the patch cord to connect to the port.
- 3 Use the VFL button to turn on the visual fault locator (refer to Figure 29).

Or, on the home screen tap **TOOLS**, then tap **Visual Fault Locator (VFL)**. You can tap the **PULSE/OFF/CW** (continuous wave) button on the screen to change the modes of the VFL, or use the button as shown in Figure 29.

- 4 Look for the red light as shown in Figure 29.
- 5 To see the light that comes out of a connector, hold a white paper in front of the fiber connector.

Notes

The fiber connector at the VFL and the fiber near the connector can emit red light when there are no faults there because the light is strong at the VFL output.

The light from the VFL is possibly not visible through dark-colored fiber jackets.

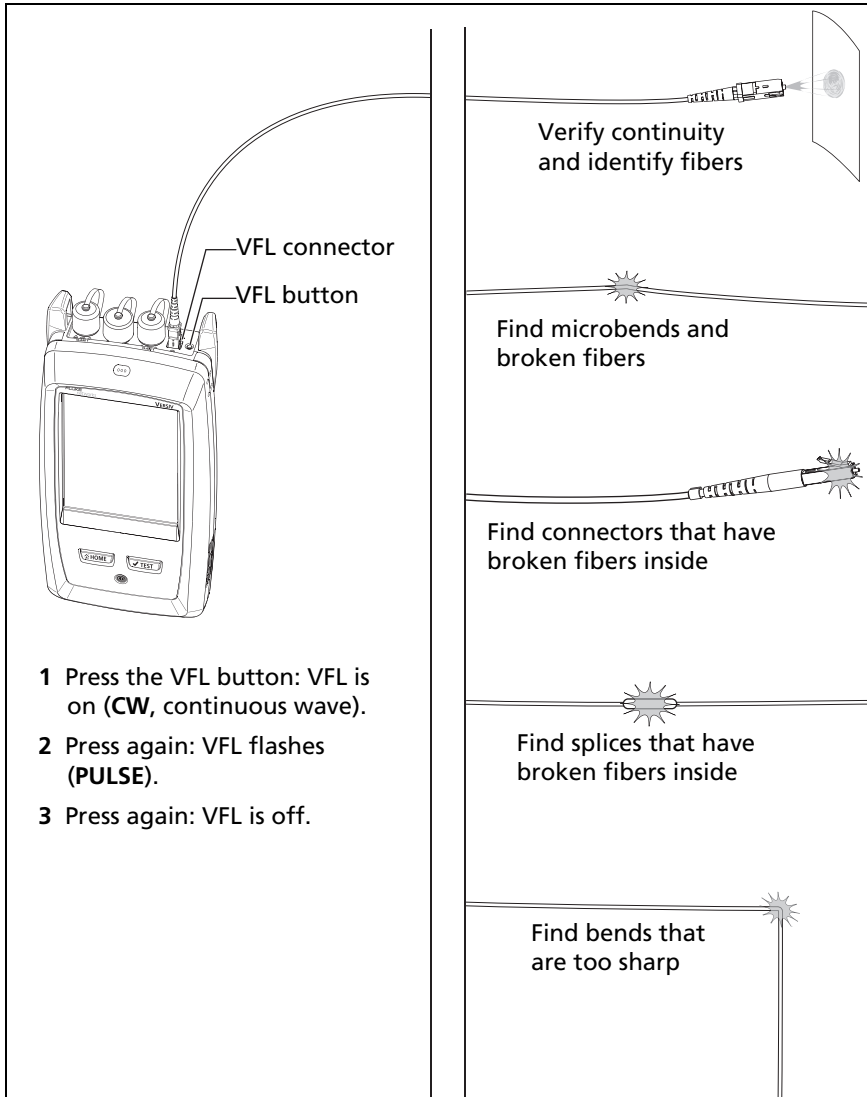

GPU07.EPS

Figure 29. How to Use the Visual Fault Locator

Chapter 6: The Power Meter and Light Source

You can use the CertiFiber Pro main tester to monitor and save measurements of optical power and loss, and you can use the main or remote tester and as an optical power source. You can use the main tester's power or loss meter and its light source at the same time.

How to Monitor Power and Loss

The power meter lets you monitor the optical power supplied by a source such as an optical network interface card or optical test equipment. You can do these tasks:

- Monitor minimum and maximum power levels in **dBm** (decibels per milliwatt), **mW** (milliwatts), **μW** (microwatts), or **nW** (nanowatts).
- Monitor power loss compared to a reference level.
- **Auto CertiFiber Pro** and **Auto SimpliFiber Pro** modes let you monitor power and loss at two wavelengths when you use a CertiFiber™ Pro or SimpliFiber® Pro source.
- Save power and loss measurements for two wavelengths in one record.

Figure 30 shows the equipment for meter measurements.

Notes

*It is not necessary to select a **Fiber Type** or **Test Limit** when you monitor power or loss. These tests do not have **PASS/FAIL** results.*

Power and loss measurements from sources that transmit network data can change as the data rate changes.

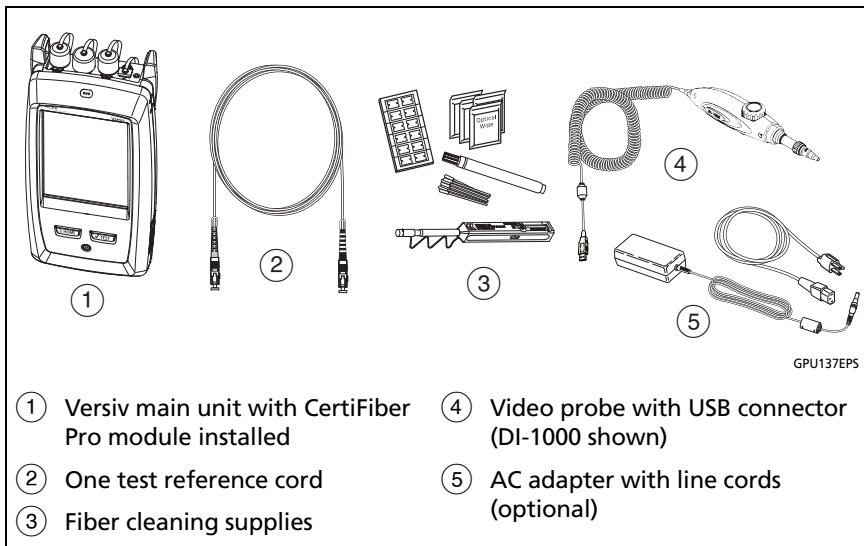
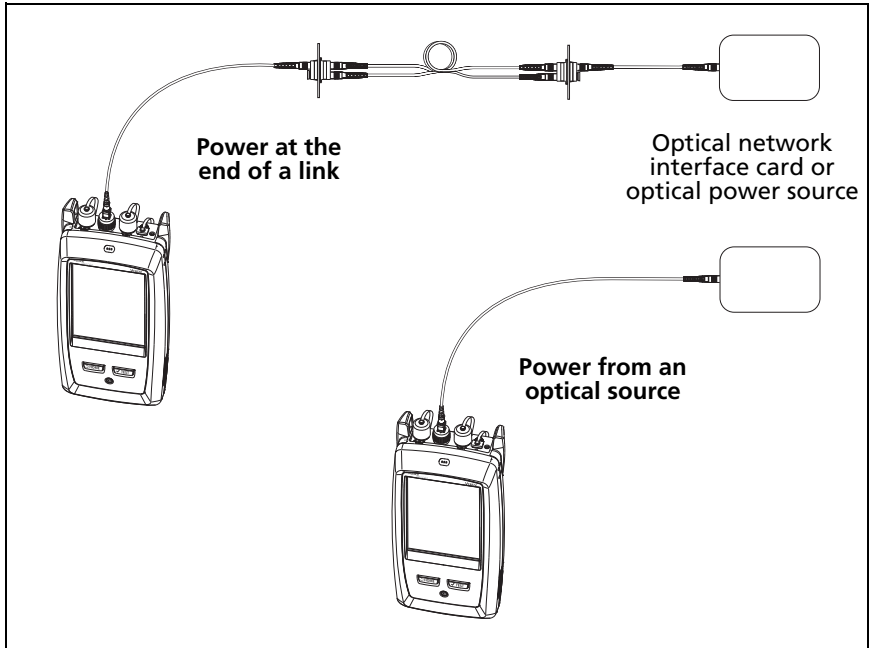

Figure 30. Equipment for Power Meter Measurements

To monitor power

- 1 Clean and inspect the tester's input port and the connectors on the source and test reference cord.
- 2 Connect the tester to the source, as shown in Figure 31.
- 3 Turn on the source. On a CertiFiber Pro module, hold down the button adjacent to the VFL port for 3 seconds.
- 4 On the home screen, tap **TOOLS**, then tap **Power Meter / Light Source**.
- 5 The default mode for the power meter is **Auto CertiFiber Pro**. If the source is not a CertiFiber Pro tester, tap λ to select the correct mode.

Figure 32 shows the power meter and its controls.



GPU138.EPS

Figure 31. Connections to Monitor Power and Loss

To monitor loss

On the **POWER METER / LIGHT SOURCE** screen, tap **REF** to use the present power level as a reference. The meters show the difference between the reference power levels and the measured power levels.

To save the power and loss measurements

- 1 On the **POWER METER / LIGHT SOURCE** screen, tap **SAVE**.
- 2 On the **SAVE RESULT** screen, select **End 1** or **End 2**, make sure the **Cable ID** and **End** name are correct, then tap **SAVE**. Saved power meter results show these icons for **End 1** and **End 2**: **PM2** **PM1**

The tester saves the present, minimum, maximum, and reference power and loss measurements for both wavelengths in one record.

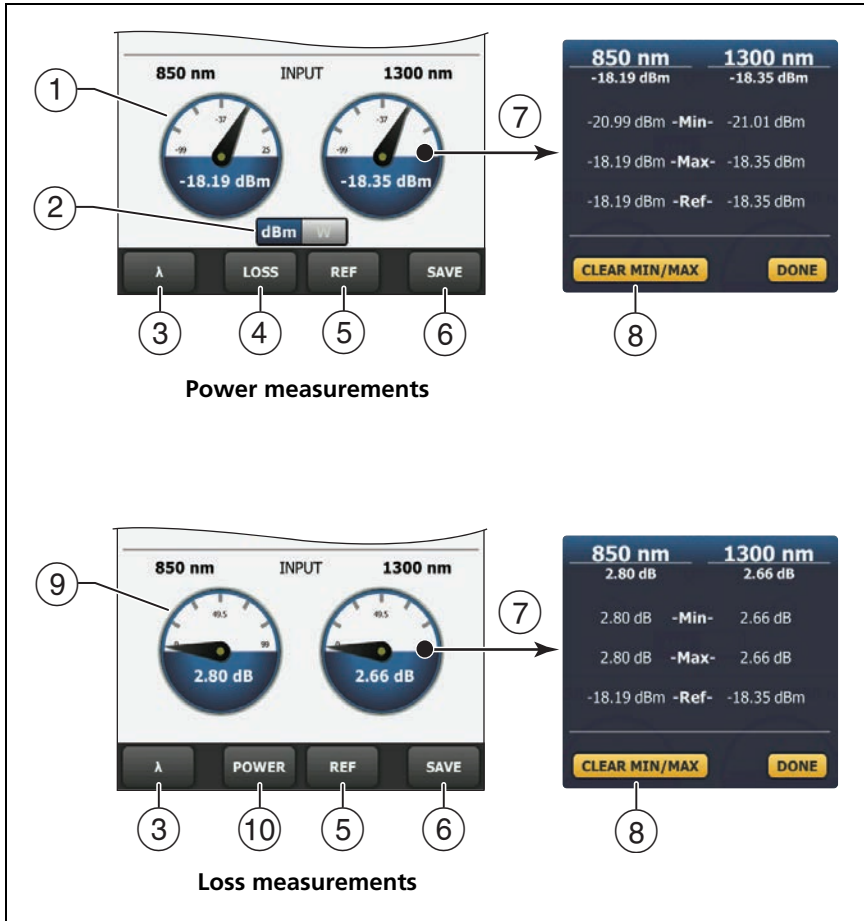

GPU126.EPS

Figure 32. Power Meter Measurements and Controls

- ① The meters show the power levels received on the input port.
- ② This control shows when the meters measure absolute power. Tap the control to see the power measurement in **dBm** (decibels per milliwatt), **mW** (milliwatts), **μW** (microwatts), or **nW** (nanowatts).

- ③ To select a wavelength for the power meter, tap λ .
Use the **Auto CertiFiber Pro** and **Auto SimpliFiber Pro** modes only with a CertiFiber Pro or SimpliFiber Pro source. In these modes, the tester reads the wavelength identifiers transmitted by the source to know when to measure power at each wavelength.
- ④ To monitor power loss (⑨), tap **LOSS** or **REF**.
- ⑤ When you tap **REF**, the tester saves the present measurements as reference levels and the meters show power loss (⑨).
- ⑥ To save the power and loss measurements, tap **SAVE**.
- ⑦ To see the present, minimum, maximum, and reference power or loss levels, tap a meter.
- ⑧ To set the minimum and maximum values to zero, tap **CLEAR MIN/MAX** in the **Min/Max/Ref** window.
- ⑨ When you tap **LOSS** or **REF**, the meters show power loss. The loss is the difference between the reference power levels and the measured power levels.
- ⑩ To monitor absolute power, tap **POWER**.

How to Control the Light Source

When you do tests in Far End Source mode, you use the button on the module to turn on the remote's light source manually. You can also turn on the main tester's light source manually and use the main tester as an optical source.

Use the Display to Control the Main Tester's Light Source

- 1 Clean and inspect all connectors you will use.
- 2 Connect the tester's output port to the power meter.
If your tester has a CertiFiber Pro Quad module installed, make sure you connect the fiber to the correct output port.
- 3 On the home screen tap **TOOLS**, tap **Power Meter / Light Source**, then select settings for the source. See Figure 33.

Use the Module's Button to Control the Light Source

The button next to the VFL port puts the output port in auto wavelength mode. In this mode, the port transmits both wavelengths (850 nm and 1300 nm or 1310 nm and 1550 nm). The signal includes identifiers that tell the meter when to measure power at each wavelength. Use this mode only with a CertiFiber Pro or SimpliFiber Pro power meter.

Note

The remote source always operates in auto wavelength mode.

- 1 Clean and inspect all connectors you will use.
- 2 Connect the tester's output port to the power meter.
If your tester has a CertiFiber Pro Quad module installed, make sure you connect the fiber to the correct output port.
- 3 Hold down the button adjacent to the VFL port for 3 seconds.
On CertiFiber Pro Quad modules, to turn on the singlemode source, press the button again.
On a main tester used as a source, you can use the **POWER METER / LIGHT SOURCE** screen to select different settings for the source. See Figure 33.

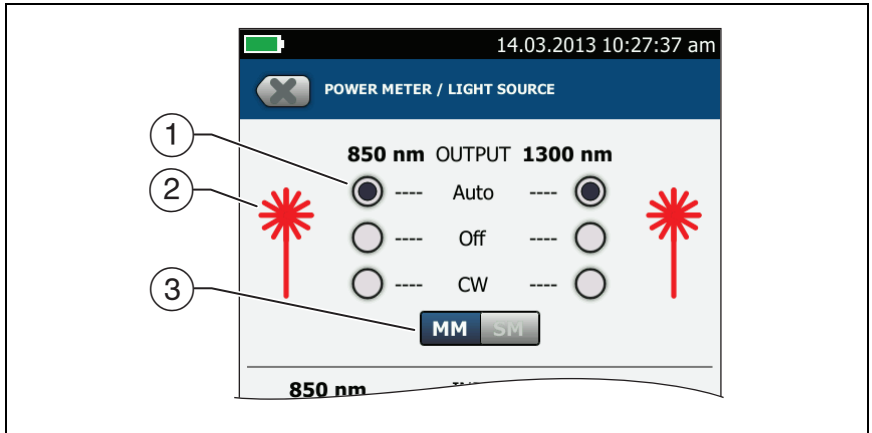

GPU127.EPS

Figure 33. Light Source Controls for the Main Tester

- ① Use the buttons to control the output port when you use the main tester as a light source:
 - **Auto:** In this mode, the output port transmits both wavelengths. The signal includes identifiers that tell a CertiFiber Pro or SimpliFiber Pro power meter when to measure power at each wavelength. Use this mode only with a CertiFiber Pro or SimpliFiber Pro power meter.
 - **Off:** The output port does not transmit the selected wavelength.
 - **CW:** The output port transmits a continuous signal at one wavelength. Use this mode if the power meter is not a CertiFiber Pro or SimpliFiber Pro meter.
- ② The laser icon is red when the output port transmits the wavelength adjacent to the icon.
- ③ When the tester has a CertiFiber Pro Quad module installed, use this control to select multimode or singlemode wavelengths

Chapter 7: Test Results

View Saved Results

On the home screen, tap the **RESULTS** icon. The **RESULTS** screen shows the results in the active project. See Figure 34.

To organize results and make reports you can give to customers, use LinkWare software.

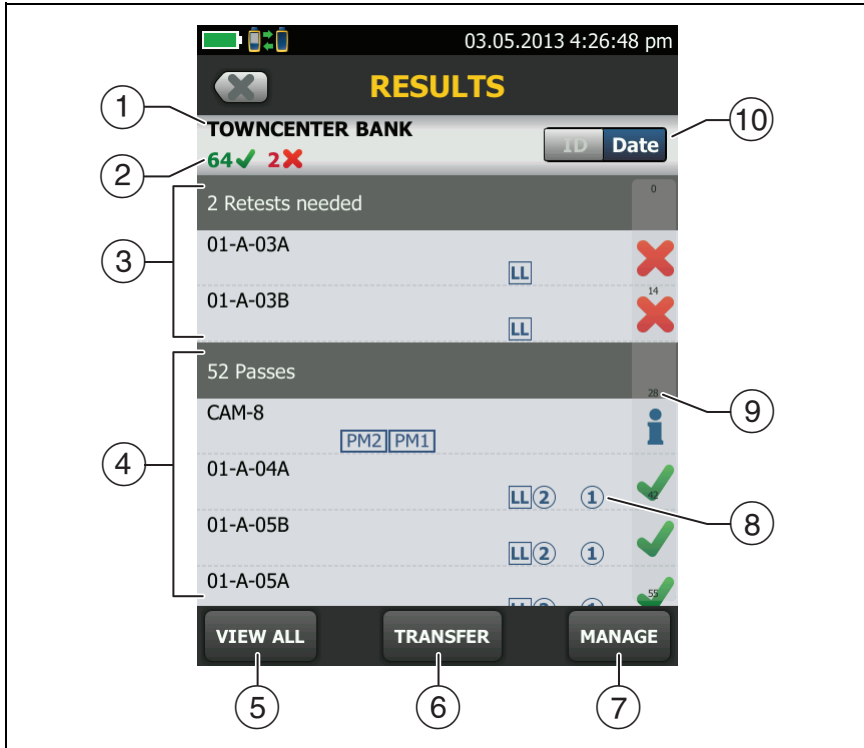



HEJ24.EPS

Figure 34. RESULTS Screen

- ① The name of the active project.
- ② : The number of results that passed. This includes individual results for each ID and tests that have an result.
- : The number of results that failed. This includes individual results for each ID.

Note



These numbers show the total number of results that passed and failed in the IDs saved. So, the numbers can be more than the number of IDs saved.



- ③ The cable IDs that have **FAIL** results and must be tested again. Because some IDs can have one or more tests that failed, the number at the top of this screen (②) can be more than the number of retests needed.
- ④ The cable IDs that have an overall **PASS** or  result. Because some IDs can have one or more tests that passed or have an  status, the number at the top of this screen (②) can be more than the number of passes.

IDs that start with "TRC" are from verification tests on test reference cords. These IDs show the date and time of the test.

- ⑤ Tap **VIEW ALL** to see a summary of the results in all the projects in the tester.
- ⑥ **TRANSFER** lets you export or import results to or from a flash drive and delete results on the flash drive.
- ⑦ **MANAGE** lets you move results to a different project, rename results, or delete results that are in the tester.
- ⑧ The icons show the types of fiber test results that the result contains:

 Loss/length results from a CertiFiber Pro OLTS module.

  Power meter results from End 2 and End 1 from a CertiFiber Pro OLTS module.

  FiberInspector results from End 2 and End 1.

A fiber result can also contain OTDR, FaultMap™, and Real Time Trace results from OptiFiber Pro modules.

- ⑨ The scroll bar shows when the list of results is long. To use the scroll bar, tap on the bar or slide your fingertip on the bar. For example, to see the 12th result in the list, tap on "12" in the scroll bar. When you slide your fingertip on the bar, the number of the result you can see is next to your fingertip.

- 10 Tap the **ID/Date** control to sort the results by cable ID or by date. When you sort by ID, the results show in ascending order. When you sort by date, the latest result is at the top of the list.

How to Add a Result to a Saved Result

You can save the results from different tests in one cable ID. For example, you can save CertiFiber Pro results and FiberInspector results together in one ID.

When you add results, these settings used to get the results must agree with the settings in the saved result:

- Test limit
- Fiber categories (singlemode/multimode, core size, category)
- Index of refraction (makes a warning you can override)

If the settings do not agree, the tester shows a warning.

To add results for a different End setting for power meter and FiberInspector tests

- 1 Do the test, then tap **SAVE**.
- 2 On the **SAVE RESULT** screen, select **End 1** or **End 2**, make sure the **Cable ID** and **End** name are correct, then tap **SAVE**.

To add results from a different test

- 1 On the home screen, tap the test setup panel.
- 2 On the **CHANGE TEST** screen, tap the button next to a test, then tap **USE SELECTED**.
 - If the ID set has a **Last ID**, the home screen shows the first ID in the set that does not have results for the test you selected.
 - If the ID set does not have a **Last ID**, tap the **Next ID** panel, tap the **Next ID** box on the **CHANGE ID** screen, enter the first ID for the set of saved results, then on the **CHANGE ID** screen, tap **DONE**.

- 3 Tap **TEST** or press , then save the result.

How to Replace a Saved Result that Failed

To use the same test settings that were used for the saved result

- 1 On the home screen, tap the **RESULTS** icon.
- 2 On the **RESULTS** screen, tap a result that failed.
- 3 Tap **TEST AGAIN**.
- 4 When the test is completed, and if **Auto Save** is on, the tester asks you if you want to overwrite the results. Tap **Yes**.

If **Auto Save** is off, tap **FIX LATER** (if the test failed) or **SAVE** (if the test passed) to save the result.

To replace a result with a result that uses different test settings

- 1 Turn off **Auto Save**.
- 2 Make sure that the home screen shows the project that contains the result you want to replace.
- 3 Select the necessary test settings.
- 4 Do the test, tap **FIX LATER** (if the test failed) or **SAVE** (if the test passed), then enter the ID of the saved result.
- 5 The tester asks you if you want to overwrite the results. Tap **Yes**.

Delete, Rename, and Move Results

Before you delete, rename, or move results, select the project that contains the results and go to the **MANAGE RESULTS** screen:

- 1 On the home screen, tap the **RESULTS** icon. The **RESULTS** screen shows the results in the active project.
- 2 To see the results in another project, tap **VIEW ALL**, then tap a project.
- 3 Tap **MANAGE** to see the **MANAGE RESULTS** screen.

To delete results

- 1 On the **MANAGE RESULTS** screen, select the results you want to delete.

To select all the tests that failed or all the tests that passed, tap **Select All Retests** or **Select All Passes**.

- 2 Tap **DELETE**, then tap **DELETE** in the confirmation dialog.

To rename results

- 1 On the **MANAGE RESULTS** screen, select one result to rename.
- 2 Tap **RENAME**.
- 3 Enter a new name, then tap **DONE**.

To move results to a different project

- 1 On the **MANAGE RESULTS** screen, select the results you want to move.
- 2 Tap **MOVE**.
 - To move the results to a project shown in the list, tap the project name, then tap **MOVE** in the confirmation dialog.
 - To make a new project and move the results to the new project, tap **NEW PROJECT**, enter a project name, tap **DONE**, then tap **MOVE** in the confirmation dialog.

Note

When you move results to a different project, that project becomes the active project.

Manage Results on a Flash Drive

You can export or import results to or from a flash drive, and delete results on the flash drive.

 **Caution**

- **Do not remove the USB flash drive while the LED on the drive flashes. Doing so can corrupt the data on the drive.**
- **You can lose a USB flash drive, cause damage to it, or accidentally erase the contents of the drive. Thus, Fluke Networks recommends that you save no more than one day of test results on a flash drive.**

Note

The tester reads only USB drives that use the FAT format.

- 1 Connect a USB flash drive to the type A USB port. The tester makes a bell sound when it detects the drive.
- 2 On the home screen, tap the **RESULTS** icon.
- 3 The **RESULTS** screen shows the results in the active project. To export results from a different project, tap **VIEW ALL** then tap a project.
- 4 Tap **TRANSFER**.
- 5 On the **TRANSFER RESULTS** screen, select a function:
 - **Export:** On the **EXPORT RESULTS** screen, select **New** or **All**, select the project that contains the results you want to export to the flash drive, then tap **EXPORT**.

New: Export only results that do not have the same IDs as results that are already on the flash drive. **All:** Export all the results from all projects in the tester.

Note

Cable IDs are case-sensitive. For example, the tester saves result with the names "A0" and "a0" in two different records.

If you select the active project, the **EXPORT RESULTS** screen shows the percentage of tests completed for the project and the percentage of results already exported to a flash drive.

- **Import:** On the **IMPORT RESULTS** screen select the project that contains the results you want to import from the flash drive, then tap **IMPORT**.
- **Delete:** On the **DELETE RESULTS** screen select the project that contains the results you want to delete on the flash drive, then tap **DELETE**.

Upload Results to a PC

To upload results to a PC from the tester or a flash drive, use LinkWare software.

- 1 Install the latest version of LinkWare software on the PC.
- 2 Turn on the tester and start LinkWare on the PC.
- 3 Use the USB cable supplied to connect the Micro-AB USB port on the tester to a type A USB port on the PC. See Figure 35.
Or connect a USB flash drive to the PC.
- 4 On the LinkWare toolbar, click , then select **CertiFiber Pro** to upload from a tester, or **Test Files (.tst)** to upload from a flash drive.
- 5 In the **Import** dialog box in LinkWare, select options for the location and the number of results to import.

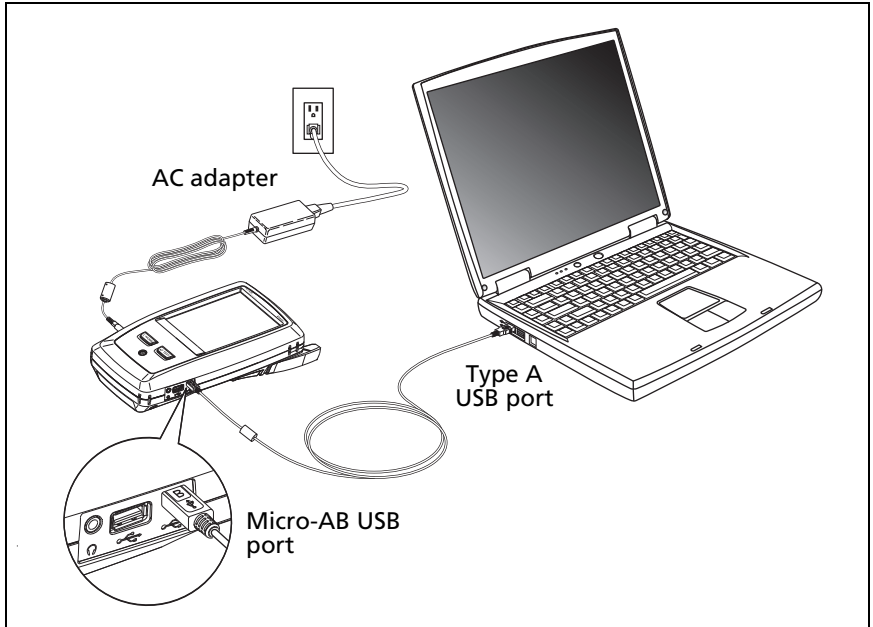

HGD46.EPS

Figure 35. How to Connect the Tester to a PC

View the Memory Status

To see the memory status

On the home screen, tap the **TOOLS** icon, then tap **Memory Status**.

The **MEMORY STATUS** screen shows these values:

- The percentage of memory available
- The number of test records that are saved
- The number of .id files that have been downloaded to the tester from LinkWare software
- The memory space taken by other files, such as the databases for projects and test limits

Chapter 8: Projects

Why Use Projects?

Projects help you monitor the status of a job and make sure that your work agrees with the requirements of the job.

You can use a project to do these tasks:

- Specify the tests that are necessary for a job.
- Specify settings for tests.
- Specify an operator for the job.
- Make sets of sequential IDs to use as names for test results.
- Automatically save test results with IDs from a set.
- Add the results from other necessary tests to each saved result in the project.
- See which IDs do not have results for a specified test.
- See what percentage of a job is completed.
- See how many links passed and how many failed.
- Keep the test results from a job in one place for easy access.

When you use a project, you can do tests and use IDs that are not specified in the project if necessary. You can also easily change the settings in a project if necessary.

Note

It is not necessary to install a module to set up a project for the module. The tester keeps all settings in the main Versiv unit.

Set Up a Project

Refer to the **PROJECT** screen in Figure 36 on page 113.

- 1 On the home screen, tap the **PROJECT** panel, tap **CHANGE PROJECT**, then tap **NEW PROJECT**.
- 2 On the **NEW PROJECT** screen, enter a name for the project, then tap **DONE**.
- 3 On the **PROJECT** screen, tap the **Operator** panel to enter an operator name for the project.
- 4 On the **PROJECT** screen, tap the **NEW TEST** button to enter the tests and test settings necessary for the project.
- 5 On the **PROJECT** screen, tap the **NEW ID SET** button to make one or more sets of cable IDs for the project. See the **CABLE ID SETUP** screen in Figure 37 on page 116.
- 6 On the **PROJECT** screen, tap **DONE**.

The PROJECT Screen



To start a new project, tap the **PROJECT** panel on the screen. Figure 36 shows the **PROJECT** screen and describes the items you enter to make a project.



HGD08.EPS

Figure 36. PROJECT Screen

- ① The name of the project. See also item ⑨.
- ② **Operator:** The name of the person who will do the tests for the project.
- ③ The date range for the results in the project.
- ④ **Results:** A summary of the test results in the project:
 - ✖: The number of tests that failed.
 - ✔: The number of tests that passed.

- ⑤ **Test Setup:** The tests that are available in the project.
To add a test to the project, tap **NEW TEST**.
- ⑥ **Cable ID Sets:** The sets of IDs the tester can use for the names of test results. Each ID set is for either copper or fiber cable.
To add a set of IDs to the project, tap **NEW ID SET**. See Figure 37.
- ⑦ To use a different project, tap **CHANGE PROJECT**, then tap a project.
To make a new project, tap **CHANGE PROJECT**, then tap **NEW PROJECT**.
- ⑧ **TRANSFER** lets you export or import projects to or from a flash drive and delete projects on the flash drive. The project data includes all project settings and test results.
- ⑨ **MANAGE** lets you rename, copy, or delete a project that is in the tester.
- ⑩ To delete the test setup or ID set, tap . To copy the test setup or ID set so you can edit it to make a new one, tap .

Note

If you delete an imported ID set from a project, the ID set is still available in the tester. To delete imported ID sets from the tester, use LinkWare software.

Note

*A project must have at least one **Test Setup** and one **Cable ID** set. If you delete them all, the tester makes a default **Test Setup** and **Cable ID** set.*

The CABLE ID SETUP Screen

To see the **CABLE ID SETUP** screen, tap the **PROJECT** panel on the home screen, then tap **NEW ID SET** on the **PROJECT** screen. See Figure 37 on page 116.

Each project can have up to 5000 IDs. If an ID set does not have a **Last ID**, the tester counts the set as one ID. An ID can have a maximum of 60 characters. Symbols, such as the asterisk, and accented characters do not increment.

About Next ID Sets

If you do not enter a **Last ID** when you make an ID set, the tester uses the **First ID** as the **Next ID**. The tester increments the Next ID each time you save a result.

- Numbers increment sequentially:
1, 2, 3, 4, 5, 6, 7, 8, 9, 10, 11, 12, ... 99, 100, 101...
- Letters increment through the English alphabet:
A, B, C, D, ... Z, AA, AB, AC, AD, ... AZ, BA, BB, BC...
- Numbers and letters do not cause each other to increment:
1Y, 1Z, 1AA, 1AB, ... 1ZZ, 1AAA, 1AAB...
- The tester does not increment symbols or accented characters.

When you use a **Next ID** set, the set under **IDs Untested** on the **CHANGE ID** screen shows only the next ID. To save the next test with a different ID, tap the **Next ID:** panel, then enter a different ID.

Each project can have one **Next ID** set.

If your project has only a **Next ID** set, the tester cannot calculate the percentage of the project that is completed, so the **% Tested** value does not show on the home screen.

If your project has both a **Next ID** set and sets with first and last IDs, the **% Tested** value includes tests you saved with **Next ID**. For

example, if you have one **Next ID** set and one set with 10 IDs, and you save 10 results with next IDs, the **% Tested** shows 50% (10 saved results divided by 20 IDs).

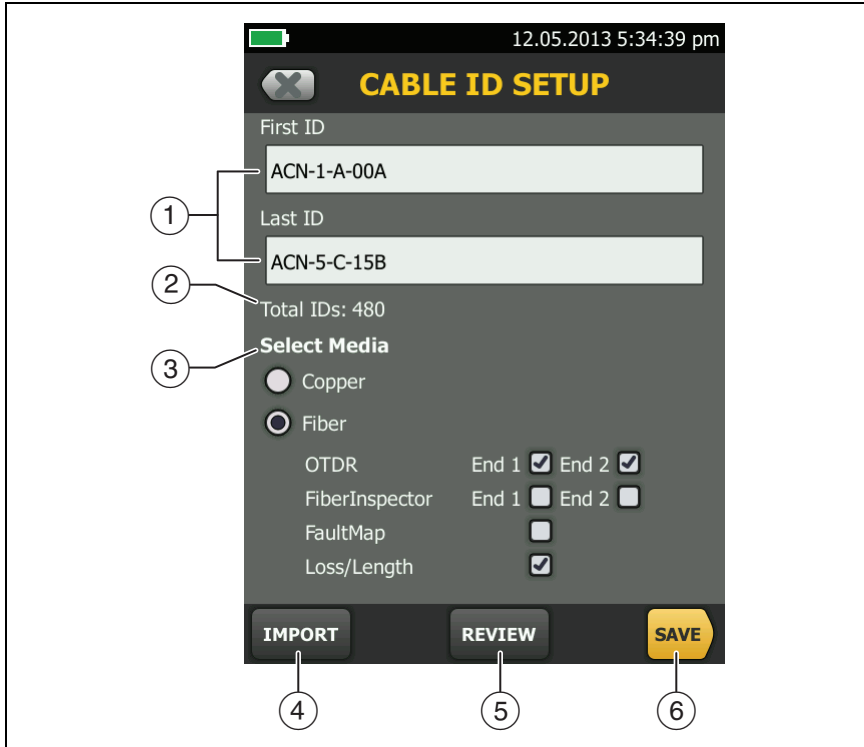

GPU09.EPS

**Figure 37. CABLE ID SETUP Screen
(after you enter the first and last IDs)**

- ① **First ID and Last ID:** The first and last IDs in a set of sequential IDs.

If you do not enter a **Last ID** when you make an ID set, the tester will increment the **First ID** to make subsequent IDs.

Note

The tester does not increment symbols or accented characters.

When you use an ID set that does not have a **Last ID**, the set under **IDs Untested** on the **CHANGE ID** screen shows only the next ID.

- ② **Total IDs:** The number of IDs in the set. This section does not show for ID sets that do not have a **Last ID**.
- ③ **Select Media:** Select **Fiber** and **Loss Length** to use the ID set to save results from tests on fiber cable. If you will do other fiber tests on the IDs, also select those tests.

For example, you can specify that you must do a **Loss Length** and a **FiberInspector** test for each ID. After you do both tests for all the IDs in the set, the tester shows **100% Tested** on the home screen. If no IDs include FiberInspector results, the tester shows **50%**. To see the IDs that need FiberInspector results, select a **FiberInspector** test in the project, then look at the list under **FiberInspector IDs Untested** on the **CHANGE ID** screen

Notes

*If you select **Copper**, the ID set will not be available when you do a fiber test.*

*The **Select Fiber Tests** section does not show for ID sets that do not have a **Last ID**.*

- ④ Tap **IMPORT** to use an ID set that you downloaded to the tester from LinkWare software.
- ⑤ Tap **REVIEW** to see the **CABLE ID REVIEW** screen, which shows the ID set and the total number of IDs.

Note

*The **REVIEW** button does not show if you do not enter a **Last ID**.*

- ⑥ **SAVE:** To save the ID set, tap **SAVE**.

Manage Projects on a Flash Drive

You can export or import projects to or from a flash drive, and delete projects on the flash drive. The project data includes all project settings and test results.

Caution

- **Do not remove the USB flash drive while the LED on the drive flashes. Doing so can corrupt the data on the drive.**
- **You can lose a USB flash drive, cause damage to it, or accidentally erase the contents of the drive. Thus, Fluke Networks recommends that you save no more than one day of test results on a flash drive.**

Note

The tester reads only USB drives that use the FAT format.

- 1 Connect a USB flash drive to the type A USB port. The tester makes a bell sound when it detects the drive.
- 2 On the home screen, tap the **PROJECT** panel.
- 3 On the **PROJECT** screen, tap **TRANSFER**.
- 4 On the **TRANSFER PROJECTS** screen, select a function:
 - **Export:** On the **EXPORT PROJECTS** screen, select the projects you want to export to the flash drive, then tap **EXPORT**.
 - **Import:** On the **IMPORT PROJECTS** screen select the projects you want to import from the flash drive, then tap **IMPORT**.
 - **Delete:** On the **DELETE PROJECTS** screen select the projects you want to delete on the flash drive, then tap **DELETE**.

Copy Project Settings to Other Testers

To copy the settings in a project to other Versiv units, use the **Read Project Setups** and **Write Project Setups** utilities in LinkWare software. You can use LinkWare to read project settings from a tester or from a project you exported to a flash drive.

Chapter 9: Maintenance

Maintenance

Warning

To prevent possible fire, electric shock, personal injury, or damage to the tester:

- Do not open the case. You cannot repair or replace parts in the case.
- Use only replacement parts that are approved by Fluke Networks.
- If you replace parts that are not specified as replacement parts, the warranty will not apply to the product and you can make the product dangerous to use.
- Use only service centers that are approved by Fluke Networks.

Caution

If you replace electrical parts yourself, the tester will possibly not have the correct calibration and can give incorrect test results. If the calibration is not correct, cable manufacturers can remove their warranty from the cabling you install.

Verify Operation

The tester does a self test when you turn it on. If the tester shows an error or does not turn on, refer to “If the Tester Does Not Operate as Usual” on page 129.

Clean the Tester

To clean the touchscreen, turn off the tester, then use a soft, lint-free cloth that is moist with water or water and a mild detergent.

To clean the case, use a soft cloth that is moist with water or water and a mild detergent.



Do not put the tester or the battery pack in water.



To prevent damage to the touchscreen or the case, do not use solvents or abrasive materials.

When you clean the touchscreen or the case, do not let liquid get under the plastic around the touchscreen.

To clean the optical connectors on the module, see the instructions in Chapter 2.

Clean the DI-1000 Video Probe

To clean the case, use a soft cloth that is moist with a mild detergent.



To prevent damage to the case, do not use solvents or abrasive materials.

To clean the lens, remove the adapter tip, then wipe the lens with an optical-grade cloth that is moist with an optical-grade cleaning solution.

Traceable Calibration Period

To make sure that the modules operate within the published specifications for accuracy, have them calibrated at a Fluke Networks authorized service center every 12 months.

See Information About the Tester

To see information about your tester and attached modules and adapters

On the home screen, tap the **TOOLS** icon, then tap **Version Information**.

To see information about a remote tester

Use CertiFiber Pro modules and patch cords to connect the main and remote testers together (see Figure 5 on page 20), then tap **REMOTE** on the **Version Information** screen.

Update the Software

New software gives you access to new features and the latest test limits and cable types. Software updates are available on the Fluke Networks website.

You can use a PC to install a software update, or connect an updated main unit to a remote or to another main unit to update those units.

To use a PC to update the software



To prevent unexpected loss of power, connect the ac adapter to the tester when you update the software.

Note

The software update procedure does not delete the test records, project settings, or user preferences in the tester, but can possibly change the factory-installed cable types or test limits.

- 1 Install the latest version of LinkWare software on your PC. LinkWare is available on the Fluke Networks website.
- 2 Download the Versiv update file from the Fluke Networks website, or contact Fluke Networks to get the update by other methods. Save the file to your hard drive.
- 3 Connect the AC adapter to the tester and connect the Micro-AB USB port on the tester to a type A USB port on the PC. See Figure 38.
- 4 On the LinkWare menu, select **Utilities > CertiFiber Pro > Software Update**, find and select the update file, then click **Open**. LinkWare saves the update file on the tester, then the tester installs the file.
- 5 The tester reboots when the update is completed. To make sure the update was installed correctly, tap the **TOOLS** icon on the home screen, tap **Version Information**, then make sure the Versiv main unit and the module show the correct version.
- 6 Do steps 3 through 5 again for the remote. On a remote tester, the LEDs show the progress of the installation.

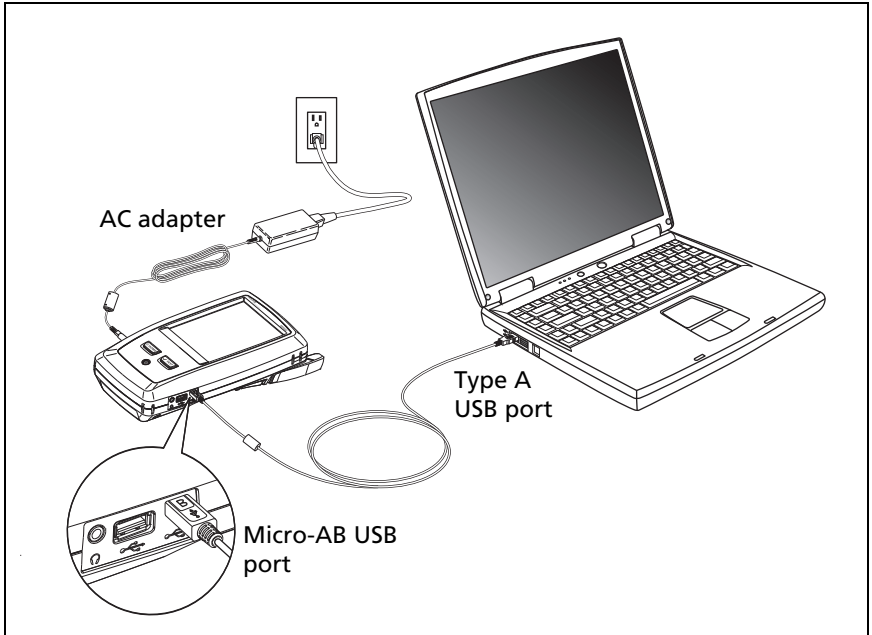

GPU46.EPS

Figure 38. How to Connect the Tester to a PC

To use an updated main unit to update a remote or another main unit

- 1 Turn on both testers and connect the AC adapters to both testers.
- 2 Use the USB cable provided to connect the updated main unit to the remote or to another main. See Figure 39.
- 3 Follow the instructions shown on the display of the updated main unit.

Note

If a remote has newer software than the main unit, the main unit can install the older software in the remote so that you can use the two units together. The remote cannot install the newer software in the main unit.

To update the software in a module

To update the software in a module, attach it to a main or remote Versiv unit that has the latest software. The tester automatically installs the software in the module.

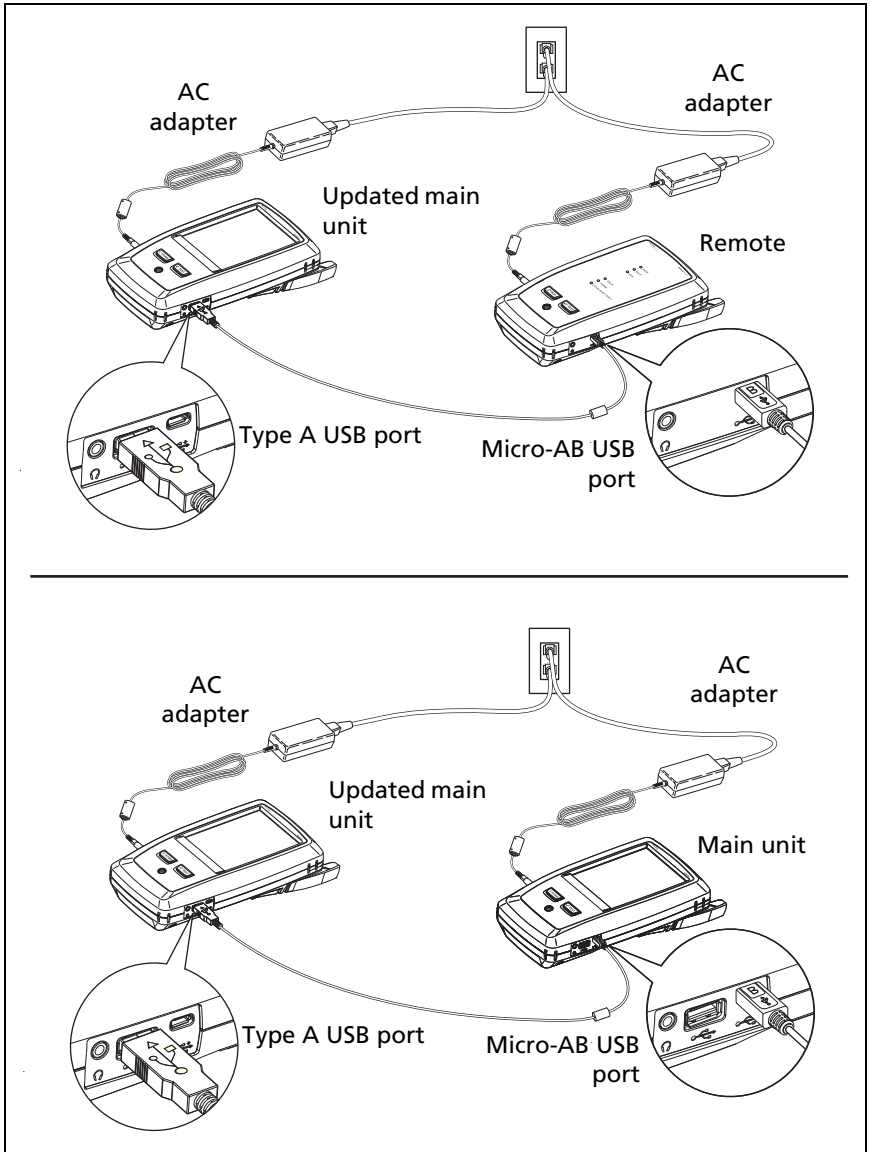

HGD116.EPS

Figure 39. How to Connect Units Together to Update the Software

Extend the Life of the Battery

- Do not frequently let the battery discharge completely.
- Do not keep the battery at temperatures below -20 °C (-4 °F) or above +50 °C (+122 °F) for periods longer than one week.
- Before you put a battery into storage, charge it to approximately 50 % of full charge.

Store the Tester

- Before you store a tester or an extra battery for a long period, charge the battery to approximately 50 % of full charge. The discharge rate of the battery is 5 % to 10 % each month. Check the battery every 4 months and charge it if necessary.
- Keep a battery attached to the tester during storage. If you remove the battery for more than approximately 24 hours, the tester will not keep the correct time and date.
- Storage temperature: -22 °F to +140 °F (-30 °C to +60 °C)

Remove the Battery

Figure 40 shows how to remove the battery.

Notes

If you remove the battery and do not connect the AC adapter, the clock keeps the current date and time for a minimum of 24 hours.

The screw does not come out of the battery door.

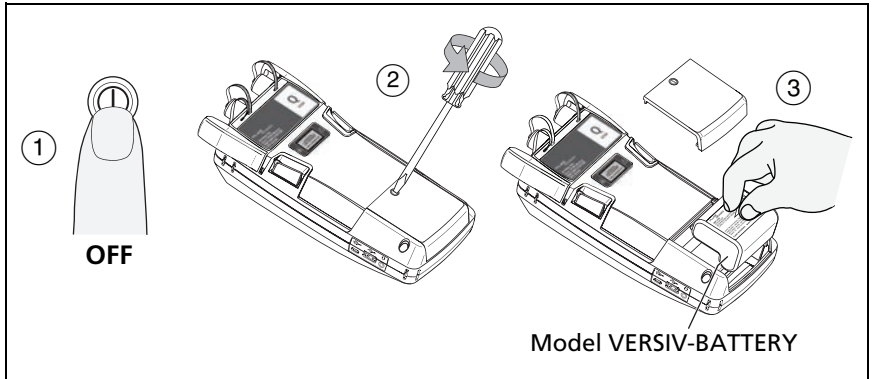

Figure 40. How to Remove the Battery

Calibration

To make sure that the modules operate within the published specifications for accuracy, have them calibrated at a Fluke Networks authorized service center every 12 months. To get information on factory calibration, contact an authorized Fluke Networks Service Center.

To see when the tester last received a factory calibration, tap the **TOOLS** icon on the home screen, then tap **Version Information**.

If the Tester Does Not Operate as Usual

If the tester does not operate as usual or if it shows an unusual message, see Table 3 for possible explanations and solutions to some conditions that can occur.

If the condition continues, contact Fluke Networks for assistance, or search the Fluke Networks Knowledge Base for a solution.

If you contact Fluke Networks, have available the serial number, software and hardware versions, and calibration date for the tester, if possible. To see this information, tap the **TOOLS** icon on the home screen, then tap **Version Information**.

You can also use LinkWare software to upload the system log from the tester. This file contains information that can possibly help Fluke Networks find a solution to an unusual problem.

To see the serial numbers of the main and remote units and modules if the tester is not operating correctly, remove the module and look at the stickers under and on the module.

Table 3. Possible Solutions for Unusual Behavior

<p>The touchscreen or the keys do not respond.</p> <p>Press and hold  until the tester turns off. Then turn on the tester. If the problem continues, install the latest version of software in the tester.</p>
<p>The tester will not turn on even though the battery is charged.</p> <p>The fuse in the battery is possibly open. Connect the AC adapter. The tester can operate on AC power if the battery does not operate.</p>
<p>Test results appear to be incorrect.</p> <p>The tester possibly has incorrect settings. Make sure you selected the correct cable type and test limit.</p>

Options and Accessories

For a complete list of options and accessories go to the Fluke Networks website at www.flukenetworks.com.

To order options and accessories, contact an authorized Fluke Networks distributor.

Certifications and Compliance

	<p>Conformite Europeene. Conforms to the requirements of the European Union and the European Free Trade Association (EFTA).</p>
	<p>Listed by the Canadian Standards Association.</p>
	<p>Conforms to relevant Australian standards.</p>
	<p>Conforms to relevant Russian standards.</p>
	<p>KCC-REM-FKN-012001001: EMC approval for Korea Class A Equipment (Industrial Broadcasting & Communication Equipment)</p> <p>This product meets requirements for industrial (Class A) electromagnetic wave equipment and the seller or user should take notice of it. This equipment is intended for use in business environments and is not to be used in homes.</p> <p>A 급 기기 (업무용 방송통신기자재)</p> <p>이 기기는 업무용 (A 급) 전자파적합기기로서 판매자 또는 사용자는 이 점을 주의하시기 바라며, 가정외의 지역에서 사용하는 것을 목적으로 합니다.</p>

Regulatory Information

This equipment generates, uses, and can radiate radio frequency energy, and, if not installed and used in accordance with the manual, may cause interference to radio communications. It has been tested and found to comply with the limits for a Class A digital device pursuant to Part 15, Subpart J of the FCC rules, which are designed to provide reasonable protection against such interference when operated in a commercial environment. Operation of the equipment in a residential area is likely to cause interference, in which case the user, at his own expense, will be required to take whatever measures may be required to correct the interference.

Appendix A: Reference Method Names

Industry standards use different names for the three reference methods. Tables A-1 and A-2 show the names used in this manual and by four common standards.

Table A-1. Reference Method Names fore TIA/EIA Standards

Link End Connections Included in Loss Results	Method Name in This Manual	TIA/EIA-526-14A (multimode)	TIA/EIA-526-7 (singlemode)
2 connections	1 Jumper	Method B	Method A.1
1 connection	2 Jumper	Method A	Method A.2
None	3 Jumper	Method C	Method A.3

Table A-2. Reference Method Names for IEC Standards

Link End Connections Included in Loss Results	Method Name in This Manual	IEC 61280-4-1 (multimode)	IEC 61280-4-2 (singlemode)
2 connections	1 Jumper	Method 2	Method A1
1 connection	2 Jumper	Method 1	Method A2
None	3 Jumper	Method 3	Method A3

Appendix B: Modified 1 Jumper Reference Method

This Appendix shows modified reference and test connections that give 1 jumper results. Use these connections if you need 1 jumper results, but do not have the correct connector adapters to connect the CertiFiber Pro modules' output ports to the link. This method lets you keep the test reference cords connected to the module's output ports when you connect the modules to the link.

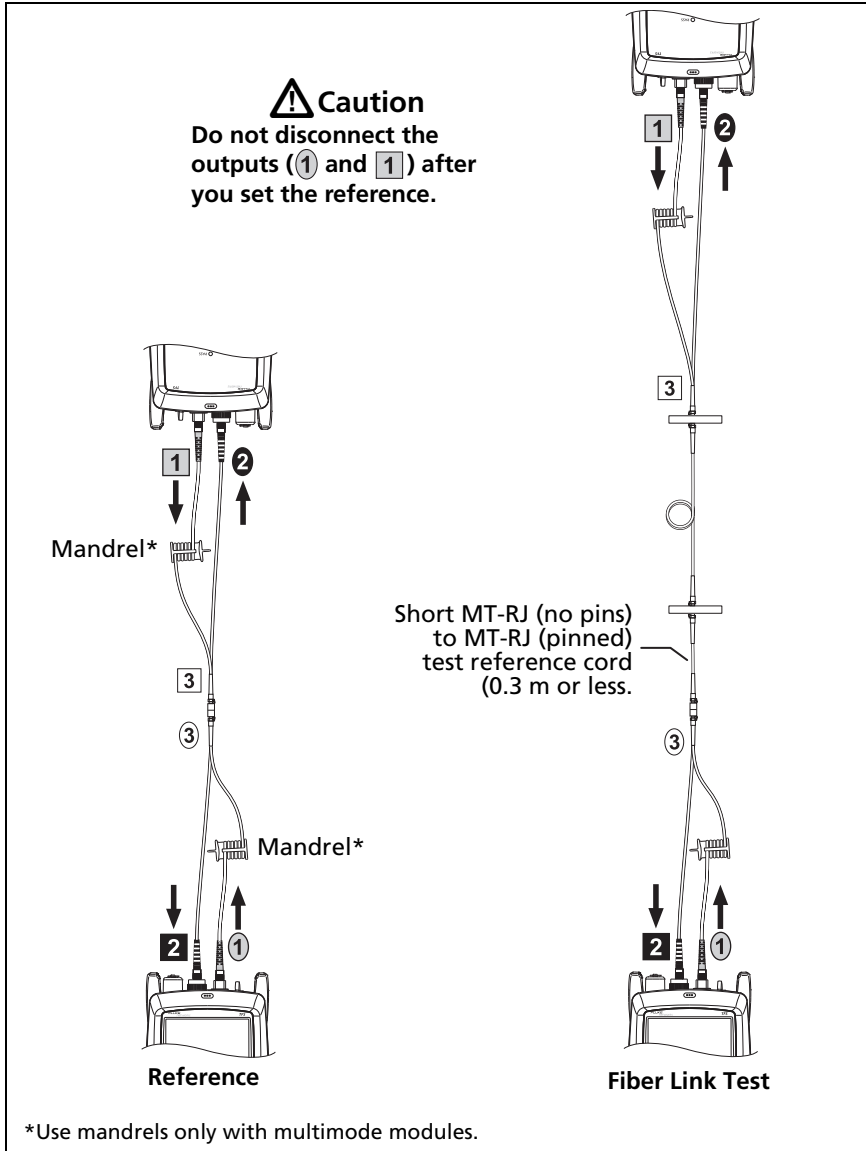

Figure B-1. Modified 1 Jumper Reference Method for Smart Remote Mode

Symbols

% Tested, 17
 how to include a test in this value,
 117

–1–

1 jumper method
 modified, 135
 standard, 55
1, 2, 3 jumper, 50

–2–

2 and 3 jumper methods, 55

–A–

ac adapter, 18
accessories
 ordering, 130
 standard, 3
APC connectors, 46
auto CertiFiber/SimpliFiber Pro
 far end source mode, 72
 power meter, 97
auto save, 26
auto wavelength mode, 99
 far end source mode, 72
 power meter, 97
Autotest
 far end source mode, 72
 loopback mode, 64
 settings, 48
 smart remote mode, 55

–B–

battery
 care, 128
 charging, 18
 removal, 128
 status, 18
 storage, 128
bi-directional
 setting, 49
 tests, 80

–C–

cable ID setup screen, 116
cautions, 8, 45
cleaning
 case, 122
 fiber connectors, 33
 IBC cleaner, 36
 touchscreen, 122
 video probe, 122
connector
 adapters on modules, 27
 APC, 46
 Certifiber Pro module, 11
 VFL, 92
connector type, 50
contact Fluke Networks, 2
customer support, 2

–D–

display
 cleaning, 122
 how to use, 21

-E-

EF-TRC, 44
encircled flux, 44
end 1/end 2
 FiberInspector, 85
 power meter, 95

-F-

far end source mode, 72
fiber type, 49
FiberInspector test
 procedure, 84
 purpose, 83
 screen, 86
fix later, 24
flash drive
 projects, 118
 results, 107
Fluke Networks
 contact, 2
 Knowledge Base, 3

-H-

help (contact Fluke Networks), 2
home screen, 15

-I-

i
 TRC verification result, 44
ID set
 copy, 114
 delete, 114
 import, 117
 make an ID set, 115
 maximum number of IDs, 115
 next ID, 115, 116
 options, 26
index of refraction, 49

-J-

jumper reference, 51
jumpers setting, 53

-K-

Knowledge Base, 3

-L-

language, 23
LinkWare and LinkWare Stats, 31
loopback mode, 64
loss is negative, 43

-M-

maintenance, 121
memory
 capacity, 25
 flash drive
 projects, 118
 results, 107
 status, 25, 110
 upload results to a PC, 108
microscope (FiberInspector), 83
module
 connectors, 10
 install or remove, 29
 setting, 49

-N-

next ID sets, 115
number of connectors and splices,
 51
number of connectors/splices, 51,
 52

-O-

operator, 16
options and accessories, 130

-P-

- parts, 130
- power meter, 93
- project
 - copy to another tester, 119
 - flash drive, 118
 - project screen, 113
 - purpose, 111
 - set up a project, 112

-R-

- reference
 - far end source mode, 74
 - fiber tests, 42
 - good values, 43
 - loopback mode, 66
 - smart remote mode, 57
- reference method, 50
- remote tester
 - battery status, 19
 - LEDs, 13
 - version information, 123
- replacement parts, 130
- results
 - add to a saved result, 104
 - delete, rename, move, 106
 - flash drive, 107
 - replace a saved result, 105
 - results screen, 102
 - upload to a PC, 108

-S-

- self test, 122
- service, 129
- settings for tests, 48
- smart remote mode, 55
- software
 - update, 123
 - version, 123
- splices setting, 51, 52

- storage, 128
- system log, 130

-T-

- talk, 17
- test again, 25
- test limit, 49
- test reference cords
 - encircled flux, 44
 - how to select, 44
 - length, 51
- test setup
 - add to a project, 114
 - copy, 114
 - delete, 114
- test type, 49
- total connections setting, 51
- touchscreen
 - cleaning, 21
 - how to use, 21
- TRC length, 51
- TRC verification, 44

-V-

- version information, 123
- visual fault locator (VFL), 89

-W-

- warnings, 121

